

Mission:

To protect, promote & improve the health of all people in Florida through integrated state, county & community efforts.



Ron DeSantis
Governor

Scott A. Rivkees, MD
State Surgeon General

Vision: To be the **Healthiest State** in the Nation

October 20, 2020

Ms. Sheryl Ervin
Senior Regulatory Specialist
Infiltrator Water Technologies
Post Office Pox 768
Old Saybrook, Connecticut 06475

Dear Ms. Ervin:

You requested review and approval of aerobic treatment units of the Delta Enviro-Aire (EA) model series that have been certified to meet the requirements of ANSI/NSF Standard 40 (Residential Wastewater Treatment Systems) for Class I classification. The test report was NSF Final Report 07/05/055/0030, dated January 2008. Per your request, the models EA52.5 and EA75 have been reviewed for compliance with the requirements of Florida Administrative Code rule 64E-6.012 and are hereby approved.

These models are housed in treatment receptacles that have as part of this approval been assigned specific approval numbers to reflect their use with Delta EA aerobic treatment units.

These receptacles are variations of receptacles by Infiltrator Water Technologies that had been previously approved by the Florida Department of Health.

Approval Number	Approval Remarks
70-143-EA5-C4	Three-compartment polypropylene tank. Two vertical, two lateral and four diagonal horizontal stiffeners. Houses Delta Enviro-Aire 52.5 (525 gal/day). IM 1060.
70-143-EA7-C4	Three-compartment polypropylene tank. Four vertical, three lateral and four diagonal horizontal stiffeners. Houses Delta Enviro-Aire EA75 (750 gal/day). Inlet/outlet reversed from usual IM 1530.

As part of this approval, this office reviewed the Delta EA installation, operation and maintenance manual, assembly instructions for the EA52.5 in the IM 1060 tank, and assembly instructions for the EA75 in the IM 1530 tank. For common reference, we include the proposed tank listing, your tank drawings with approval comments, assembly instructions, and a notice of rights.

Florida Department of Health

Division of Disease Control & Health Protection • Bureau of Environmental Health
4052 Bald Cypress Way, Bin A-08 • Tallahassee, FL 32399
PHONE: 850/245-4250 • FAX: 850/487-0864

FloridaHealth.gov



Accredited Health Department
Public Health Accreditation Board

Ms. Ervin
Page Two
October 20, 2020

If you have further questions, please contact Ms. Debby Tipton at Debby.Tipton@flhealth.gov or 850-901-6944.

Sincerely,

A handwritten signature in blue ink, appearing to read "Ed Barranco". The signature is stylized with a large, sweeping loop at the end.

Ed Barranco, MPH, CEHP, CPM
Environmental Administrator
Onsite Sewage Programs

EB/dt
Enclosures

NOTICE OF RIGHTS

A party whose substantial interest is affected by this order may petition for an administrative hearing pursuant to sections 120.569 and 120.57, Florida Statutes. Such proceedings are governed by Rule 28-106, Florida Administrative Code. A petition for administrative hearing must be in writing and must be received by the Agency Clerk for the Department, within twenty-one (21) days from the receipt of this order. The address of the Agency Clerk is 4052 Bald Cypress Way, BIN # A02, Tallahassee, Florida 32399-1703. The Agency Clerk's facsimile number is 850-413-8743.

Mediation is not available as an alternative remedy.

Your failure to submit a petition for hearing within 21 days from receipt of this order will constitute a waiver of your right to an administrative hearing, and this order shall become a 'final order'.

Should this order become a final order, a party who is adversely affected by it is entitled to judicial review pursuant to Section 120.68, Florida Statutes. Review proceedings are governed by the Florida Rules of Appellate Procedure. Such proceedings may be commenced by filing one copy of a Notice of Appeal with the Agency Clerk of the Department of Health and a second copy, accompanied by the filing fees required by law, with the Court of Appeal in the appropriate District Court. The notice must be filed within 30 days of rendition of the final order.



DEPARTMENT OF HEALTH

STATE HEALTH OFFICE

SEPTIC TANK DESIGNATED APPROVAL NUMBERS

SEPTIC TANK MANUFACTURERS

run date: 10/20/2020

Searching for: Delta Enviro-Aire

Infiltrator Water Technologies, LLC

4 Business Park Road; P.O. Box 768

Old Saybrook, CT 06475

ACTIVE

TANK NUMBER	CATEGORY	WALL THICKNESS	LIQUID DEPTH	TOP EXTERIOR		IN-OUT DROP	EFFECTIVE GALLONS	TOTAL	APPROVAL	
				WIDTH	LENGTH			GALLONS (Pump Tanks)	USE	DATE
70-143-EA5-C4	C4	0.20	44.00	62.2	127	3	1090	1,280		10/20/2020
REMARKS: Three compartment polypropylene tank. Two vertical, two lateral and four diagonal horizontal stiffeners. Houses Delta Enviro-Aire 52.5 (525 gal/day). IM 1060.										
70-143-EA7-C4	C4	0.20	44.00	61.7	176.6	3	1537	1,760		10/20/2020
REMARKS: Three compartment polypropylene tank. Four vertical, three lateral and four diagonal horizontal stiffeners. Houses Delta Enviro-Aire EA75 (750 gal/day). Inlet/outlet reversed from usual IM 1530.										

70-143-EA5-C4

Three compartment polypropylene tank. Two vertical, two lateral and four diagonal horizontal stiffeners. Houses Delta Enviro-Aire 52.5 (525 gal/day). IM 1060.

Approved 10/20/2020

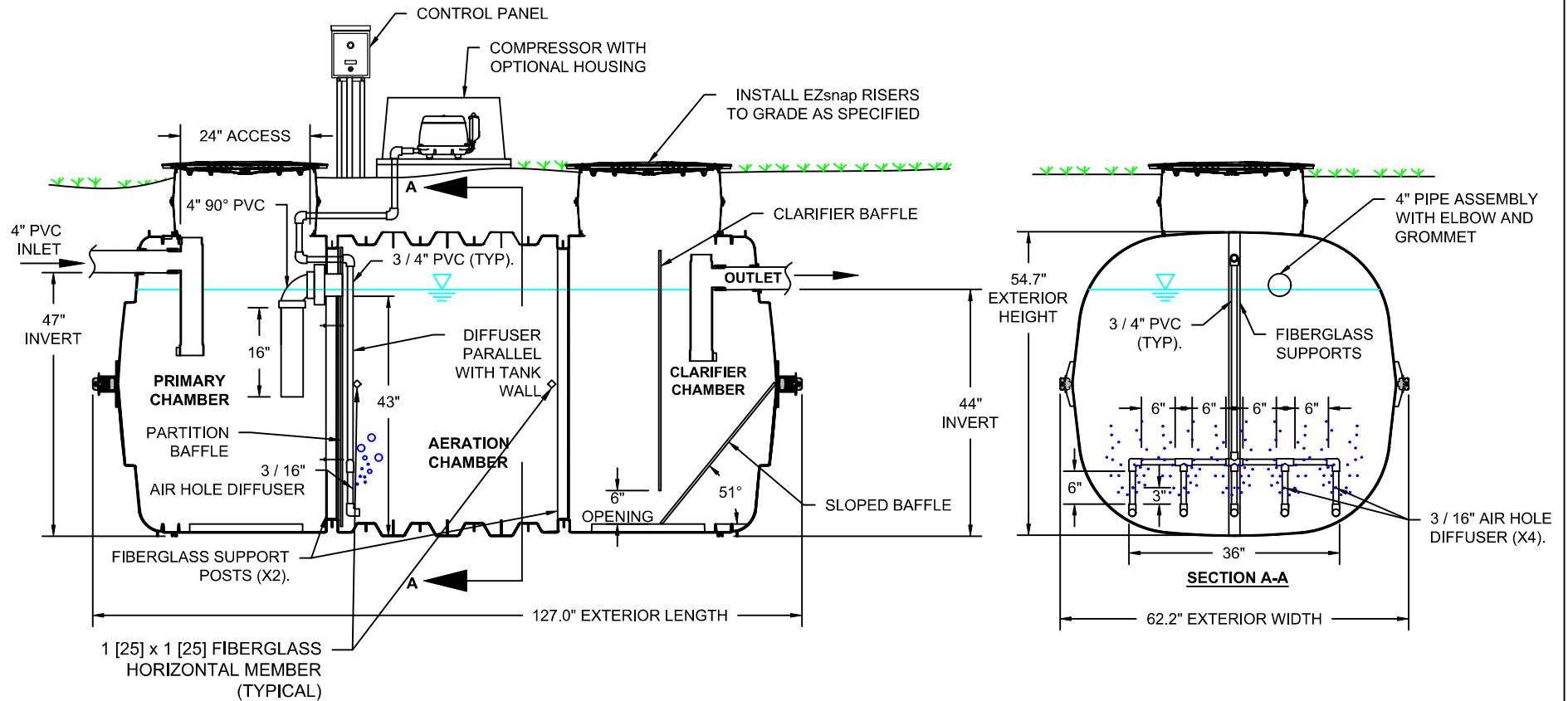

NOTES:

1. INSTALL ENVIRO-AIRE AREOBIC TREATMENT UNIT PER INSTALLATION INSTRUCTIONS.
2. INSTALL TANK PER INSTALLATION INSTRUCTIONS.
3. AIR COMPRESSOR INSTALLED WITHIN 100 FT OF THE TANK.
4. FLORIDA CATEGORY 4 BRACING INCLUDES TWO (2) HORIZONTAL STIFFENERS AND FOUR (4) DIAGONAL STIFFENERS.
5. DIAGONAL AND HORIZONTAL STIFFENERS NOT SHOWN.

		CATEGORY 4 IM-1060 WITH ENVIRO-AIRE EA52.5 TYPICAL CROSS SECTION DETAIL	
DELTA TREATMENT SYSTEMS, LLC 9125 Comar Dr. Walker, LA 70785 (800) 219-9183		Drawn by: JLK	Date: 9/16/2020
		Scale: NOT TO SCALE	Checked by:
		Sheet: 1 OF 1	

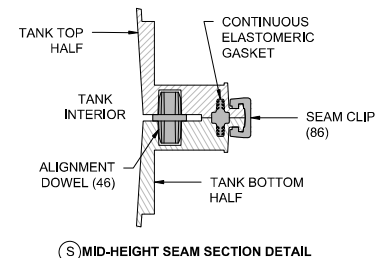
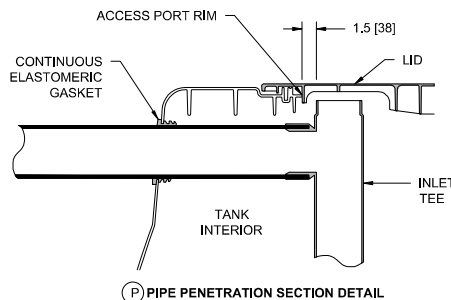
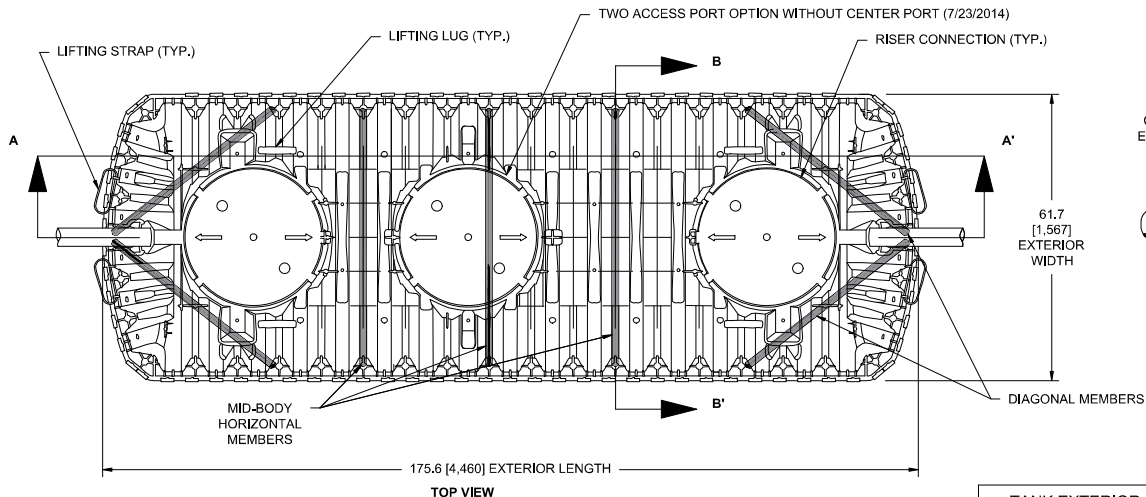

TANK EXTERIOR	
LENGTH	175.6 [4,460]
WIDTH	61.7 [1,567]
HEIGHT	54.5 [1,384]

LIQUID DEPTH	44.0 [1,118]
INVERT DROP	3.0 [76]
FREEBOARD	10.1 [257]

TOTAL CAPACITY	1,750 GAL [6,624 L]
WORKING VOLUME	1,537 GAL [5,818 L]

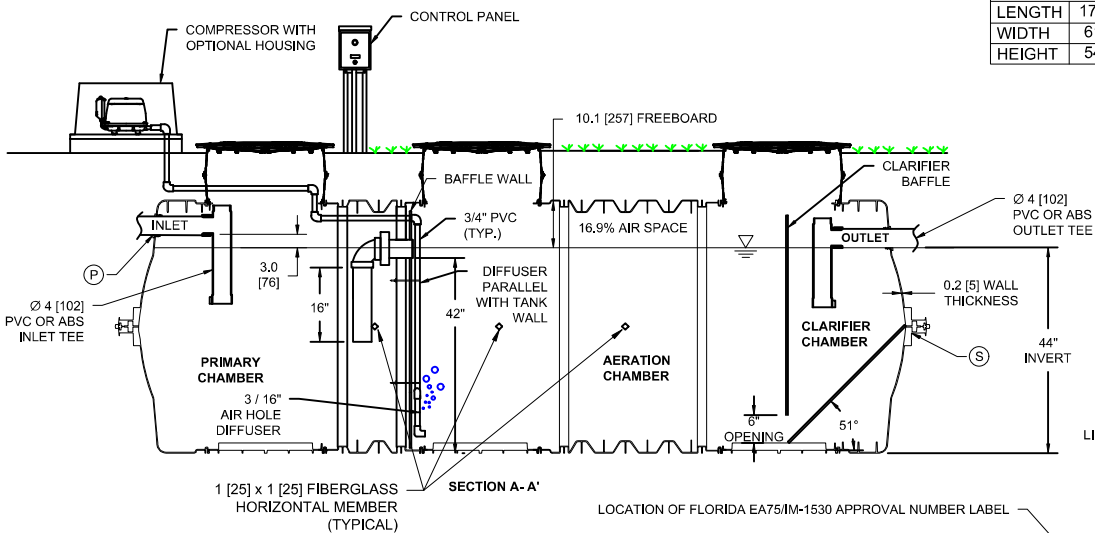

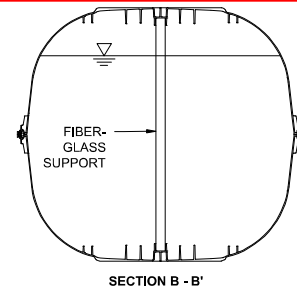
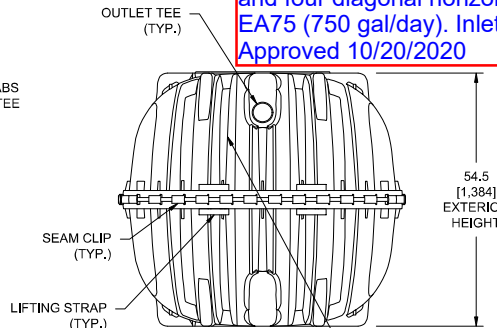

70-143-EA7-C4
 Three compartment polypropylene tank. Four vertical, three lateral and four diagonal horizontal stiffeners. Houses Delta Enviro-Aire EA75 (750 gal/day). Inlet/outlet reversed from usual IM 1530. Approved 10/20/2020

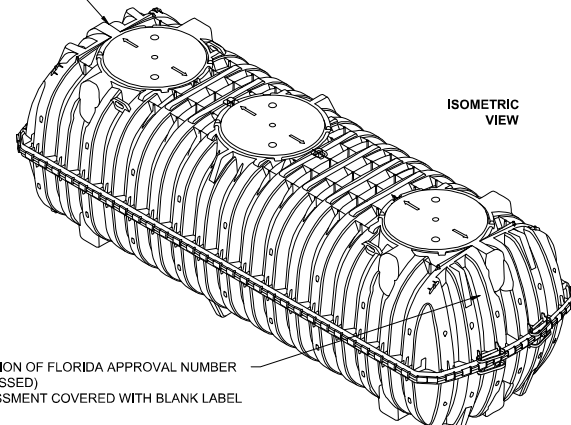

NOTICE: THIS DRAWING IS FOR THE EA75 TO BE INSTALLED IN THE IM-1530 TANK ONLY.

- NOTES:
- THIS DRAWING IS FOR THE EA75 INSTALLED IN THE IM-1530 ONLY.
 - ALL DRAWING DIMENSIONS IN INCHES [MILLIMETERS] OR AS NOTED.
 - EXTERIOR OF ACCESS OPENING LID INCLUDES THE FOLLOWING WARNING IN ENGLISH, FRENCH & SPANISH: "DANGER DO NOT ENTER: POISON GASES."
 - TANK MARKINGS WILL INCLUDE: MANUFACTURER NAME, MODEL NUMBER, LIQUID CAPACITY, DATE OF MANUFACTURE, MAXIMUM BURIAL DEPTH, INLET, AND OUTLET.
 - MAXIMUM BURIAL DEPTH IS 48 in [1,219 mm].
 - MINIMUM BURIAL DEPTH IS 6 in [152 mm].
 - TANK IS FOR NON-TRAFFIC APPLICATIONS.
 - AIRSPACE IS 16.9%.
 - TANK IS FOR NON-TRAFFIC APPLICATIONS.
 - AIRSPACE IS 16.9%.
 - OUTLET TEE IS COMPATIBLE WITH AN EFFLUENT FILTER.
 - LENGTH TO WIDTH RATIO IS 2.8:1 (175.6-INCH LENGTH / 61.7-INCH WIDTH = 2.8).





INFILTRATOR WATER TECHNOLOGIES
 4 Business Park Rd. Old Saybrook, CT 06475
 (800) 221-4436

FL EA75 IN IM-1530

Drawn by: RDD	Date: 9/15/2020
Scale: NOT TO SCALE	Checked by: JKL Sheet: 1 of 1