

Advanced Enviro-Septic®(AES) Treatment System

Kansas

Design and Installation Manual



Made in USA

✓ Minimizes the Expense ✓ Protects the Environment ✓ Preserves the Site



Presby Environmental, Inc.
The Next Generation of Wastewater Treatment Technology

143 Airport Rd., Whitefield, NH 03598
Tel: 800-473-5298 Fax: (603) 837-9864
Email: info@presbyeco.com

www.PresbyEnvironmental.com

The information in this manual is subject to change without notice. We make a continual effort to improve our Manuals in order to ensure they are as complete, accurate and helpful as possible. Please confirm that this is the most recent and up-to-date version of this Manual by contacting us at (800) 473-5298 or visiting our website, www.presbyenvironmental.com

Your questions, suggestions and comments are welcome. Please contact us at:

Presby Environmental, Inc.
143 Airport Road
Whitefield, NH 03598
Phone: 1-800-473-5298 Fax: (603) 837-9864
Website: www.PresbyEnvironmental.com

IMPORTANT NOTICES: This Manual is intended ONLY for use in designing and installing Presby Environmental's Advanced Enviro-Septic® Wastewater Treatment System. The use of this Manual with any other product is prohibited. The processes and design criteria contained herein are based solely on Our experience with and testing of Advanced Enviro-Septic®. Substitution of any other large diameter gravelless pipe will result in compromised treatment of wastewater and other adverse effects. This Manual sets forth the Manufacturer's recommendations and requirements; designers and installers are responsible for determining and complying with applicable State and/or Local regulations.

**Advanced Enviro-Septic® U.S. Patent Nos. 6,461,078; 5,954,451; 5,606,786; 6,899,359; 6,792,977 and 7,270,532 with other patents pending.
Canadian Patent Nos. 2,300,535; 2,185,087; 2,187,126 with other patents pending.
Multi-Level™ Advanced Enviro-Septic® U.S. Patent No. 6,290,429 with other patents pending.**

**Enviro-Septic® is a registered trademark of Presby Environmental Inc.
Advanced Enviro-Septic® is a pending trademark of Presby Environmental, Inc.**

Table of Contents

	<u>Pages</u>
Section A, Introduction	1-4
Section B, Components	5-7
Section C, System Sizing, AES Pipe Requirements & Design Example	8-9
Section D, System Configurations	10-20
Section E, Design Criteria for Kansas	21-26
Section F, Pumped System Requirements	27
Section G, Venting Requirements	28-31
Section H, Site Selection	32
Section I, System Sand & Fill Material Specifications	33
Section J, Preparing for Installation	34-35
Section K, Installation & Construction Procedures	36-38
Section L, Final Grading	39-40
Section M, Operation & Maintenance	41
Section N, Rejuvenation & Expansion of AES Systems	42

**Advanced Enviro-Septic® Treatment System
Kansas Design and Installation Manual**

Section A, Introduction

**What is
Advanced
Enviro-Septic®?**

Advanced Enviro-Septic® (“AES”) is an innovative onsite wastewater treatment system that is passive, non-mechanical and does not use pressure distribution. The primary component is a large diameter perforated, multi-layer fabric-wrapped pipe that is installed in a bed of specified System Sand. The Advanced Enviro-Septic® System is designed to purify wastewater that has received primary treatment in a septic tank and to disperse the treated wastewater into the underlying soils. The system is extremely versatile and can be designed in a variety of shapes and sizes, making it adaptable to virtually any residential or commercial application. The amount of pipe required and the size of the System Sand bed adjust in relation to the amount of daily design flow, the soil’s characteristics and site constraints, ensuring effective treatment and adequate absorption into underlying soils.

**How Does
Advanced
Enviro-Septic®
work?**

By utilizing simple yet effective natural processes, the Advanced Enviro-Septic® Treatment System treats septic tank effluent in a manner that prevents suspended solids from sealing the underlying soil, increases system aeration, and provides a greater bacterial area (“biomat”) than conventional septic systems.

**Why is
Advanced
Enviro-Septic®
Better?**

The Advanced Enviro-Septic® Treatment System retains solids in its pipe and provides multiple bacterial surfaces to treat effluent prior to its release into the soil. The continual cycling of effluent (the rising and falling of liquid inside the pipe) enhances bacterial activity. No other passive wastewater treatment system design offers this functionality. Our systems excel because they are more efficient, last longer, and have a minimal environmental impact.

**System
Advantages**

- Provides superior treatment
 - Thoroughly tested to prove it works
 - Preserves the natural terrain
 - Cost-effective to construct and operate
 - Completely passive, requires no mechanical devices or electricity
 - Design versatility to adapt to virtually any site, any flow, any application
 - Quicker and easier to install
 - Enhanced function and longevity
 - Requires no special maintenance
 - Superior track record of reliability
 - Made using recycled plastic
-

Introduction, continued

Purpose

The purpose of this Manual is to provide general information regarding the design criteria, installation procedures and use and care instructions for the Advanced Enviro-Septic® Treatment System.

The Advanced Enviro-Septic® System is extremely versatile and, as a result, this Manual cannot possibly set forth every conceivable system configuration. We encourage you to contact our Technical Advisors, who will be happy to address any questions or concerns unique to your project or assist you in designing a system for special applications.

Presby Environmental Standards

All systems using the Advanced Enviro-Septic Treatment™ System must be designed and installed in compliance with the procedures and specifications described in this Manual. Exceptions to any requirements in this Manual require Presby Environmental, Inc. (PEI) approval.

Conflicts Between Kansas Rules & this Manual

In the event of contradictions between this Manual and Kansas and/or local rules, PEI should be contacted for technical assistance.

Certification Required

PEI requires all designers and installers to be certified. Certification is obtained by completing the “Advanced Enviro-Septic® Certification Course” presented by PEI or its sanctioned representative. We offer a variety of certification training options, including online webinars and DVDs. Please visit our website, www.PresbyEnvironmental.com.

Special note: PEI highly recommends that all individuals involved in the approval, permitting or inspection process also complete a certification course.

Technical Support

PEI provides technical support free of charge to all individuals using our products or involved in the permitting process. For any questions about our products or the information contained in this Manual, please contact us at (800) 473-5298, send an email to info@presbyeco.com or visit our website, www.PresbyEnvironmental.com.

Disclaimer

The technical support staff at Presby Environmental, Inc. is committed to providing comprehensive product information and support via telephone, website and email at no cost to our customers. The assistance we are able to provide in this way is based on limited information and therefore should be considered general in nature. Accordingly, Presby Environmental, Inc. disclaims any liability whatsoever in connection with providing technical support.

ADVANCED ENVIRO-SEPTIC™ WASTEWATER TREATMENT SYSTEM

WITH BIO-ACCELERATOR™

TEN STEPS OF WASTEWATER TREATMENT: ADVANCED ENVIRO-SEPTIC™
TREATS EFFLUENT MORE EFFICIENTLY TO PROVIDE LONGER SYSTEM LIFE
AND TO PROTECT THE ENVIRONMENT.

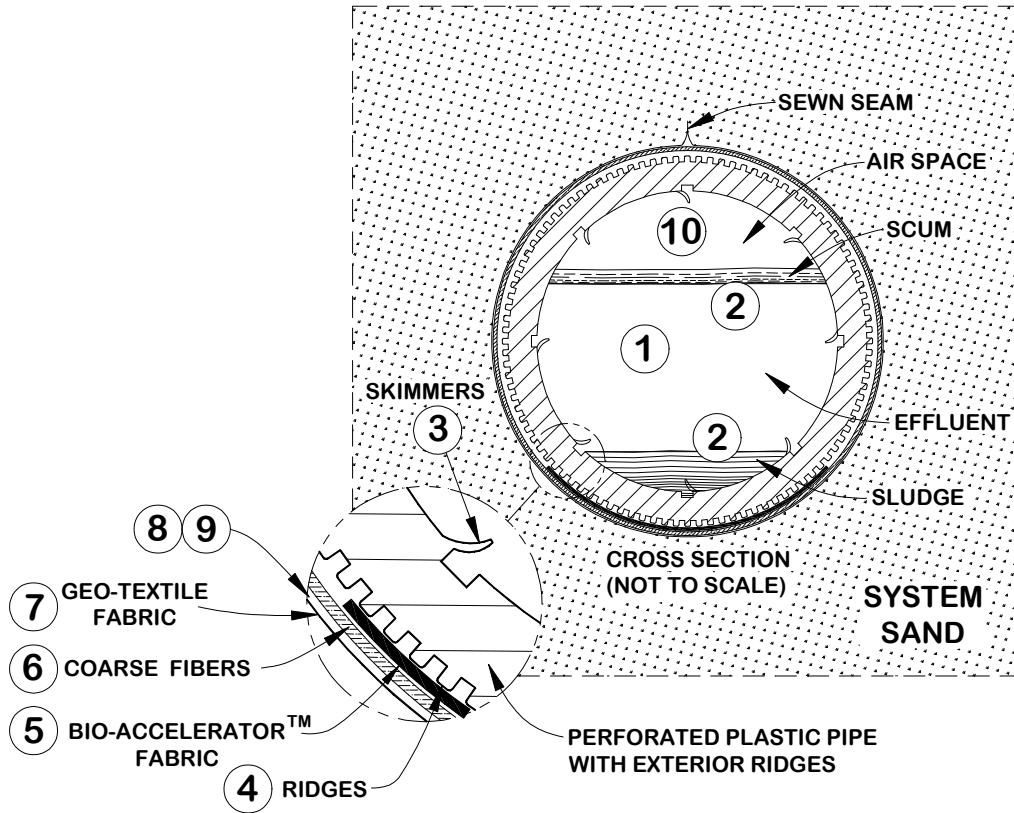

Stage 1	Warm effluent enters the pipe and is cooled to ground temperature.
Stage 2	Suspended solids separate from the cooled liquid effluent.
Stage 3	Skimmers further capture grease and suspended solids from the existing effluent.
Stage 4	Pipe ridges allow the effluent to flow uninterrupted around the circumference of the pipe and aid in cooling.
Stage 5	Bio-Accelerator™ geo-textile fabric filters additional solids from the effluent, enhances and accelerates treatment, facilitates quick start-up after periods of non-use, provides additional surface area for bacterial growth, promotes even distribution, and further protects outer layers and the receiving surfaces so they remain permeable.
Stage 6	A mat of coarse random fibers separates more suspended solids from the effluent.
Stage 7	Effluent passes into the geo-textile fabric and grows a protective bacterial surface.
Stage 8	Sand wicks liquid from the geo-textile fabric and enables air to transfer to transfer to the bacterial surface.
Stage 9	The fabric and fibers provide a large bacterial surface to break down solids.
Stage 10	An ample air supply and fluctuating liquid levels increase bacterial efficiency.

SYSTEM DIAGRAM

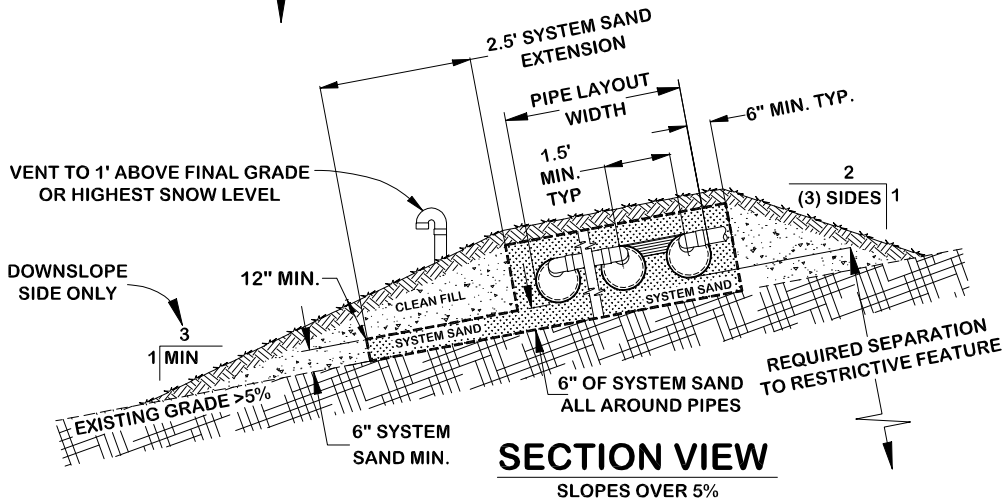
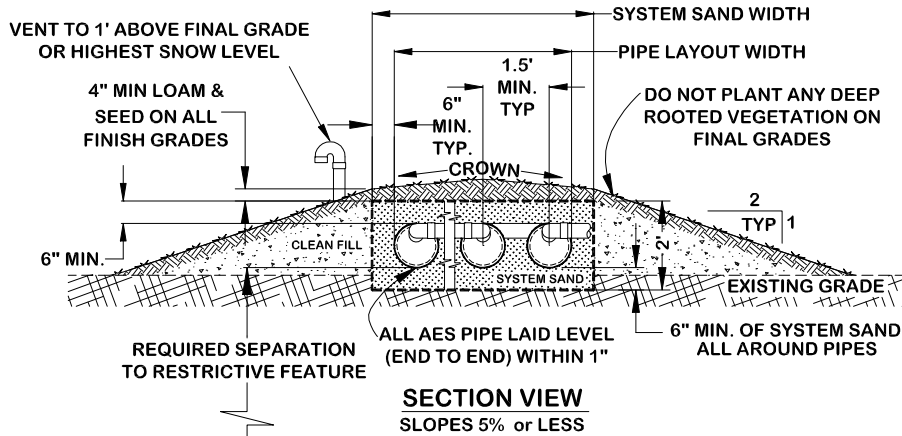
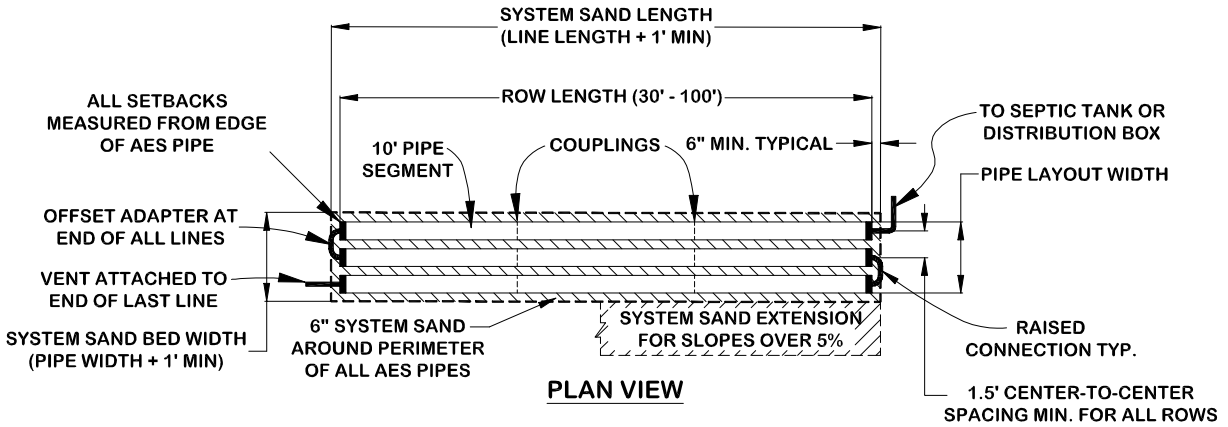

NOTES:

- ALL ROWS 1.5' SPACING MINIMUM.
- ROWS CENTERED IN SYSTEM SAND IF SLOPE IS 5% OR LESS.
- ROWS GROUPED TO UPSLOPE SIDE OF SYSTEM SAND IF SLOPE > 5%.
- VENTING REQUIRED FOR ALL CONFIGURATIONS.
- DIFFERENTIAL VENTING REQUIRED FOR ALL PUMP SYSTEMS.

Section B

Advanced Enviro-Septic® System Components

Advanced Enviro-Septic® pipe



- Plastic pipe made with a significant percentage of recycled material
 - 10 ft. units (can be easily cut to any length)
 - Ridged and perforated with skimmer tabs on interior
 - Bio-Accelerator™ layer aligned along bottom of pipe exterior
 - Covered with a mat of randomly-oriented plastic fibers
 - Surrounded by a non-woven geo-textile fabric stitched in place
 - Exterior diameter of 12 in.
 - Each 10 ft. unit has a liquid holding capacity of approx. 58 gallons
 - Flexible enough to bend up to 90°
-

Offset adapter



An offset adapter is a plastic fitting with a 12 in. diameter and a hole designed to accept a 4 in. inlet pipe, raised connection, or vent pipe. The hole is to be in the twelve o'clock position.

Note: The hole in the offset adapter will accommodate Schedule 20 to 40 PVC.

Double offset adapter

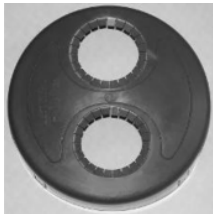

A double offset adapter is a plastic fitting with a 12 in. diameter and two holes designed to accept a 4 in. inlet pipe, raised connection, vent or vent manifold, and/or bottom drain piping (see illustration on p. 6), depending upon the particular requirements of the design configuration.

The two 4 in. holes are to be aligned in the 12 o'clock and 6 o'clock positions. The holes are positioned 1 in. from the outside edge of the double offset adaptor and 2 in. from each other.

Note: The holes in the double offset adapter will accommodate Schedule 20 to 40 PVC.

Coupling



A coupling is a plastic fitting used to create a connection between two pieces of Advanced Enviro-Septic® pipe. The coupling features a snap-together locking device and ridges that are designed to fit over the ridges of the Advanced Enviro-Septic® pipe, creating a quick and easy way to join pipe sections together easily and securely.

Advanced Enviro-Septic® System Components, continued

Bottom Drains A bottom drain is a line connected to the end of each serial section or row which drains to a sump. Bottom drains are utilized to lower the water level in a saturated system or facilitate Rejuvenation. Bottom drains are recommended for systems installed in hard-to-access areas, especially under hardscape.

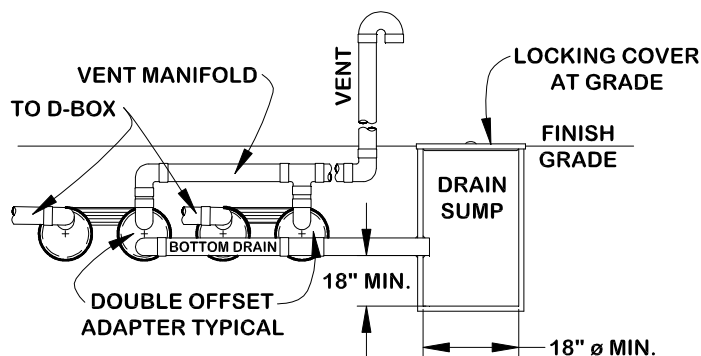

Notes:

- 1) For serial distribution attach bottom drain to end of each serial section.
 - 2) For D-box configuration attach bottom drain to end of each row.
-

Distribution Box A Distribution Box, also called a "D-box," is a device used to distribute effluent coming from the septic tank in a system that contains more than one section or more than one bed. D-boxes are also sometimes used for velocity reduction (see p. 26). D-boxes come in various sizes and with a varying number of outlets. Concrete D-boxes are preferred, some are made of plastic.

Flow equalizers (see below) are installed in the D-box openings to equalize distribution; they help ensure equal distribution in the event that the D-box settles or otherwise becomes out of level. Unused openings in D-boxes are to be covered, plugged or mortared.

Flow Equalizers A flow equalizer is an adjustable plastic insert installed in the outlet holes of a distribution box to equalize effluent distribution to each outlet whenever flow is divided.

Raised Connection A raised connection is a PVC pipe configuration that is used to connect Advanced Enviro-Septic® rows. We recommend using sewer and drain pipe for raised connections, Schedule 20 to 40 PVC can also be used. See illustration in Section K, Installation & Construction Procedures, p. 36-38.

Component Handling & Storage

- Keep mud, grease, oil, etc. away from all components.
- Avoid dragging pipe through wet or muddy areas.
- Store pipe on high and dry areas to prevent surface water and soil from entering the pipes or contaminating the fabric prior to installation.
- The outer fabric of the Advanced Enviro-Septic® pipe is ultra-violet stabilized; however, this protection breaks down after a period of time in direct sunlight. To prevent damage to the fabric, cover the pipe with an opaque tarp.

Advanced Enviro-Septic® System Components, continued

Septic Tank

- The Advanced Enviro-Septic® System is designed to treat effluent that has received “primary treatment” in a standard septic tank.
 - Unless specified by state/local regulations, the septic tank capacity should be:
 - No less than 1,000 gallons
 - 2.5 times Daily Design Flow for systems up to 5,000 gpd (gallons per day)
 - 2.0 times the Daily Design Flow for systems 5,001 to 10,000 gpd
 - 1.75 times the Daily Design Flow for systems over 10,000 gpd.
 - Septic tank capacity should be increased by 50% if a garbage disposal is used.
 - Septic tanks used with the Advanced Enviro-Septic® System must be fitted with inlet and outlet baffles in order to retain solids in the septic tank and to prevent them from entering the Advanced Enviro-Septic® System.
 - Effluent filters are not recommended by Presby Environmental, Inc. due to their tendency to clog, which cuts off the oxygen supply that is essential to the functioning of the Advanced Enviro-Septic® System.
 - If you are required to use an effluent filter in a gravity fed system due to state or local requirements, the effluent filter selected must allow the free passage of air to ensure the proper functioning of the system.
-

System Sand

The System Sand that surrounds the Advanced Enviro-Septic® pipes is an **essential** component of the system. It is **critical** that the correct type and amount of System Sand is used when constructing the system. System Sand must be coarse to very coarse, clean, granular sand, free of organic matter. It must adhere to **all** of the following percentage and quality restrictions:

- No stones over $\frac{3}{4}$ in. in diameter
- Percentage Restrictions (by total weight):
 - 35% maximum retained by a #10 sieve
 - 40-90% retained by a #35 sieve
 - Fines Quality Restrictions: A maximum of 2% of total sand may pass through a #200 sieve
- ASTM C-33 sand may be acceptable for use as System Sand providing that no more than 2% can pass a #200 sieve.

System Sand is placed a minimum of 6 in. in all directions from the Advanced Enviro-Septic® pipes (below pipes, between rows, above pipes and around outer perimeter).

Section C - System Sizing, AES Pipe Requirements & Design Example

Table A

Soil Characteristics			Soil Loading Rate (SLR) gal/day/sq.ft.
Texture	Structure		
	Shape	Grade	
Very coarse sand	Single Grain	Structureless	2.40
Coarse sand, sand, loamy coarse sand, loamy sand			
Fine sand, very fine sand, loamy very fine sand			
Coarse sandy loam, sandy loam	Massive	Structureless	0.90
	Platy	Weak	
		Prismatic, blocky, granular	Moderate
			Weak
Fine sandy loam, very fine sandy loam	Massive	Structureless	0.90
	Platy	Weak, moderate	
		Prismatic, blocky, granular	Weak
			Moderate, strong
Loam	Massive	Structureless	0.75
	Platy	Weak, moderate	
		Prismatic, blocky, granular	Weak
			Moderate, strong
Silt loam	Massive	Structureless	0.40
	Platy	Weak, moderate	0.65
		Prismatic, blocky, granular	Weak
			Moderate, strong
Sandy clay loam, clay loam, silty clay loam	Massive	Structureless	-
	Platy	Weak, moderate	0.40
		Prismatic, blocky, granular	Weak
			Moderate, strong
Sandy clay, clay, silty clay	Massive	Structureless	-
	Platy	Weak, moderate	0.40
		Prismatic, blocky, granular	
			Moderate, strong

Table B Perc Rate Sizing for Advanced Enviro-Septic™					
MPI to SLR		Min. Units of AES Per Bedroom	% System Slope Maximum	% Site Slope Maximum	Bed Configurations Allowed
Percolation Rate minutes per inch	Soil Loading Rate (SLR)				
1 to 4	2.40	5	25	33	All Standard Bed Configurations
5 to 10	1.90				
10 to 15	1.75				
16 to 20	1.50	6	20	25	
21 to 30	1.20				
31 to 40	1.00	7	15	20	
41 to 50	0.90				
51 to 60	0.75				
61 to 80	0.65				
81 to 95	0.45				
96 to 120	0.40	0	5	Basic Serial or Multiple Beds	

System Sizing, AES Pipe Requirements & Design Example, continued

Calculating the Amount of AES pipe required

- Residential systems require 5, 6 or 7 AES pipes (10 ft.) per bedroom depending on soil's perc rate. Refer to Table B, p. 8.
 - Commercial system pipe requirements are calculated at 1 ft. of AES pipe per 2 gallons per day of design flow:
-

Requirements Assume Normal Domestic Strength Effluent

System Sand Bed Sizing and minimum AES pipe requirements presented here were developed assuming normal, domestic strength effluent which has received primary treatment in a septic tank.

When designing a system that will treat unusual or high strength wastes, using additional AES pipe is recommended. Please consult our Technical Staff at (800) 473-5298 for guidance.

Design Example

Design a four bedroom residential AES System in soils with a perc rate of 15 mpi:

- 15 mpi perc rate = SLR 1.75 gpd/sq.ft. per Table A, p. 8.
- Daily design flow (residential) is calculated at 150 gpd per bedroom
- 4 bedrooms @ 150 gpd = 600 gpd daily design flow
- $600 \text{ gpd} \div 1.75 \text{ SLR (Table A)} = 343 \text{ sq.ft.}$ System Sand bed area (minimum)
- Minimum AES pipe from Table B, p. 8, 4 bedrooms x 5 units each = 200 ft.

AES Pipe Layout Examples (a few of the many possible configurations):

- 4 rows of pipe 50 ft. long or
- 5 rows of pipe 40 ft. long
- Both use minimum required amount of pipe, 20 units (200 ft.)

System Sand Bed Dimensions - Example:

- Assume 4 rows of pipe, 50 ft. long
- Sand Bed length: 50 ft. row length + 1 ft. System Sand (6 in. each end) = 51 ft. Sand Bed length
- Min. System Sand Bed width: $343 \text{ sq. ft.} \div 51 \text{ ft. length} = 6.725 \text{ ft.}$ (round up to 6.8 ft.) width (minimum).

Confirm Bed Width above will accommodate number of rows:

- Minimum System Sand bed width for 4 rows using 1.5 ft. center-to-center spacing is 6.5 ft. Bed width does not have to be increased to accommodate 4 rows. Use minimum bed width of 6.8 ft.
 - 51 ft. System Sand bed length x 6.8 ft. wide System Sand will provide 346.8 sq.ft., which is sufficient to meet the minimum System Sand Bed area required.
-

Section D System Configurations

Introduction

This section presents the various design configurations of the Advanced Enviro-Septic® System. The system configuration to be used is determined by:

- Characteristics of the naturally-occurring soils (percolation rate or “perc rate” in minutes per inch). Refer to Table B, p. 8.
 - Slope of the site
 - Other characteristics specific to the particular site
 - The daily design flow
-

System Configurations

The following Advanced Enviro-Septic® System configurations are presented in this Section:

- Basic Serial (pp. 11-12)
- End-to-end (“Butterfly”) and D-box configurations (p. 12)
- Combination Serial (pp. 13-14)
- Multiple Bed (pp. 15-16)
- Unique Site Solutions for any soil type (p.17)
- Unique Site Solutions with restrictions (p. 18)

Also in this Section:

- Vertical placement of the System (p. 19)
 - Orientation of the Pipes on the System Sand Bed (p. 20)
-

Basic Serial Distribution

Introduction

- Basic Serial distribution interconnects Advanced Enviro-Septic® rows in serial distribution.
- Basic Serial distribution is preferred for single beds of 600 gpd or less and multiple beds where each bed receives 600 gpd or less.
- Basic Serial distribution may be used in all soil types.
- All beds must have a minimum of two rows.
- When the system slope is 5% or less, the rows are centered on the System Sand bed; when the slope is greater than 5%, rows are grouped upslope 6 in. from the edge of the System Sand as shown in illustrations below.

Note: Basic Serial distribution is installed with a series of Advanced Enviro-Septic® rows connected at the ends with raised connections, using offset adapters and Schedule 20 to 40 PVC pipe.

D-box

A D-box is not required for gravity systems in Basic Serial configuration (unless D-box is needed for velocity reduction. Refer to p. 26.)

Flow Equalizers

Flow equalizers are not required when pumping to a D-box for a Basic Serial system.

Centered Bed Configuration – System Slopes 5% and less:

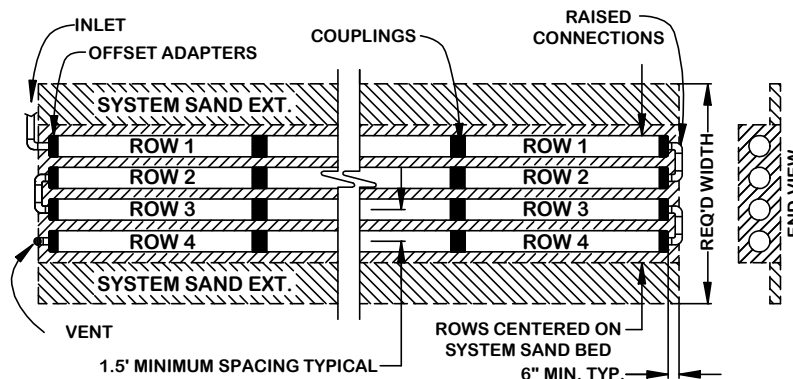

Grouped Upslope Configuration – System Slopes greater than 5%

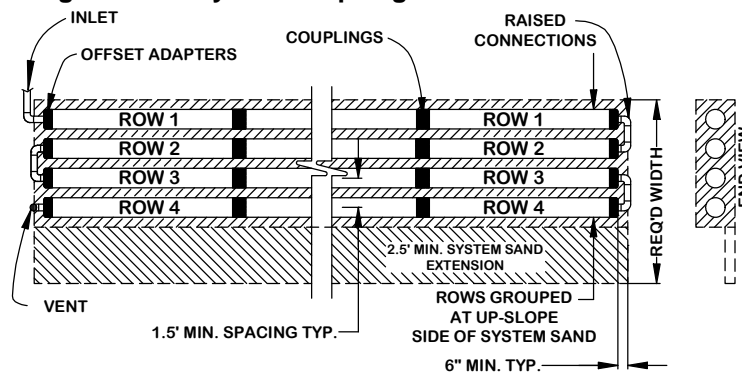

Basic Serial Configuration, continued

End-to-End Configuration – Basic Serial Distribution (“Butterfly” Configuration)

(Each section must contain at least the minimum ft. of Advanced Enviro-Septic® pipe required)

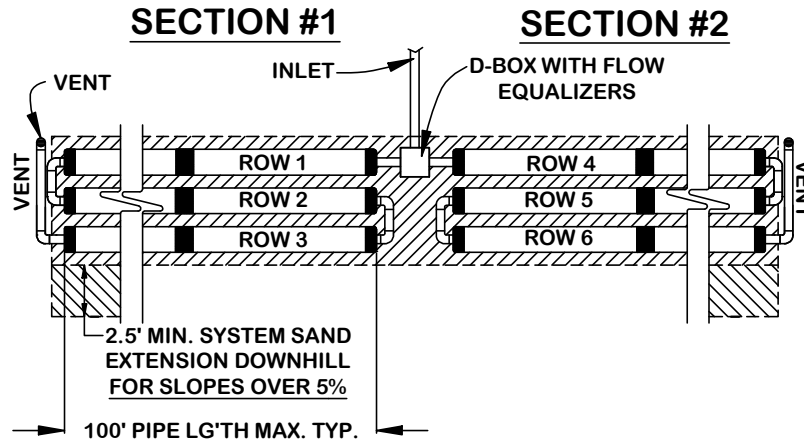

D-Box Distribution Configuration (a.k.a. “Parallel” or “Finger” configuration)

- All rows in a D-box configuration must be the same length and utilize flow equalizers to ensure effluent is distributed equally to each row in the system.
- Use a vent manifold to ensure adequate air flow through each row.
- Row lengths less than 30 ft. using this configuration are limited to use in soils with perc rates 1-60 mpi .

D-Box Distribution Configuration:

Level Bed

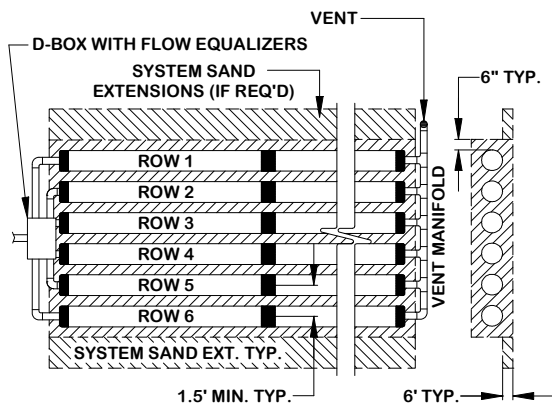

Bed Sloping more than 5%

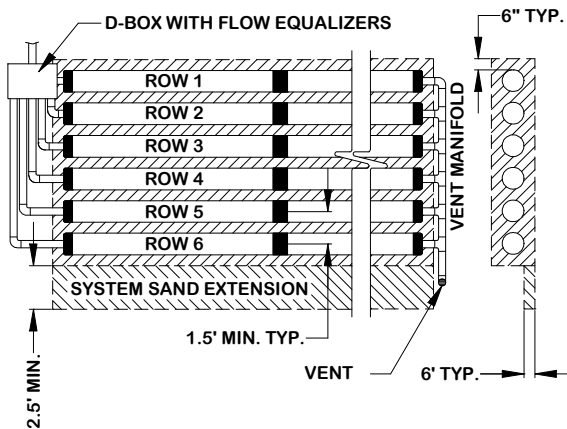

Combination Serial Distribution

Introduction

- Combination Serial distribution incorporates two or more Sections in a single bed, each Section receiving an equal amount of effluent from a D-box with flow equalizers.
- Combination Serial distribution is required for systems with daily design flows greater than 600 gallons per day (gpd) in a single bed.
- Combination Serial distribution is restricted to use in soils with perc rates 1-60 mpi.
- All beds must have at least two rows.

Note: Combination Serial distribution is installed in a bed of two or more Sections. Each Section of Combination Serial distribution is a series of Advanced Enviro-Septic® rows connected at the ends with raised connections, using offset adapters and PVC pipe. An offset adapter is used at the end of each Section to enable the installation of required venting. Refer to Section G, Venting Requirements, pp. 28-31.

When to Use Combination Serial Distribution

- Soils with perc rates 1-60 mpi.
 - Daily design flow is greater than 600 gpd/bed
-

Flow Equalizers Required

All D-boxes used to divide effluent flow require flow equalizers in their outlets. Flow equalizers are limited to a maximum of 20 gallons per minute (gpm) per equalizer.

Section Loading

Each Section in a Combination Serial system has a maximum daily design flow of 600 gpd.

To determine the number of sections required, divide the daily design flow in gpd by 600 and round up to the nearest whole number.

Example: Daily design flow of 750 gpd ÷ 600 = 1.25, round up to 2 sections.

Section Length Requirement

- Each Section must have the same minimum linear feet of pipe.
 - The minimum linear feet of pipe per Section is determined by dividing the total linear feet required in the Advanced Enviro-Septic® System by the number of Sections required. (Note: This is a minimum, individual Section lengths can be longer but cannot be shorter.)
 - Rows may vary in length to accommodate site constraints (See Unique Site Solutions, p. 18).
-

Combination Serial Distribution Illustration

The following illustration shows a plan view of multiple Sections in a single bed. Each Section contains the same minimum feet of pipe, and each receives an equal amount of effluent from a D-box with flow equalizers.

Combination Serial Distribution, continued

Combination Serial Distribution –

(equal linear footage of Advanced Enviro-Septic® pipe in each section)

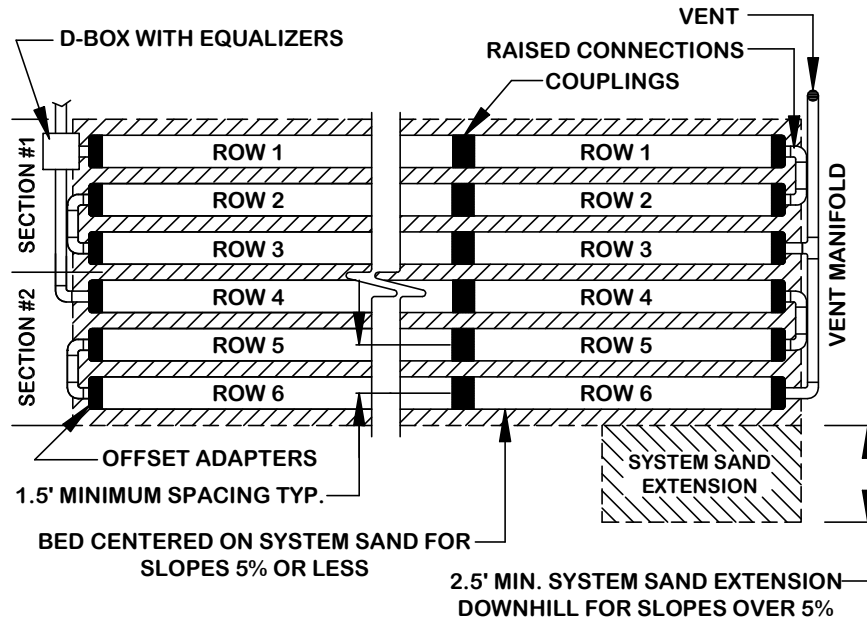

End-to-End Combination Serial Distribution

End-to-end Combination systems are configured the same as Basic Serial “Butterfly systems” (see illustration on p. 12).

- This configuration would be considered a single bed with multiple serial sections.
- There is only one System Sand Bed under all the sections.
- Each serial section must contain the minimum required Advanced Enviro-Septic® pipe. Divide the amount of pipe required by the number of serial sections to determine the minimum pipe needed in each section.
- Row lengths can vary within a serial section.
- Flow equalizers are required on all used D-box outlets.

Multiple Bed Distribution

Introduction

Multiple Bed distribution may be used to accommodate site constraints or to handle large daily design flows. It incorporates:

- Two or more beds
- Each bed with Basic Serial or Combination Serial distribution
- Each bed receives an equal amount of effluent from a D-box with equalizers.
- In soils with perc rates 61-120 mpi, multiple beds must use Basic Serial Distribution for daily design flows greater than 600 gpd.

When to use Multiple Bed Distribution

- Daily design flow is greater than 600 gpd
- Required in perc rates 61-120 mpi when daily design flow exceeds 600 gpd

Flow Equalizers Required

All D-boxes used to divide effluent flow require flow equalizers in their outlets. Each flow equalizer is limited to a maximum of 20 gpm in both gravity and pumped systems.

Bed Requirements

- Each bed must have the same minimum total feet of pipe
- Each bed must have at least two rows
- The minimum linear feet of pipe per bed is determined by dividing the total linear feet required in the Advanced Enviro-Septic® System by the number of beds.
- Beds may be of different dimensions, provided that rows are not more than 100 ft. long. Longer, more narrow beds work best.
- Recommended minimum row length is 30 ft.
- Rows within a bed may vary in length to accommodate site constraints.

Multiple Bed Orientation

Multiple beds may be oriented along the contour of the site or along the slope of the site. End-to-end configurations are preferred; however, side-to-side configurations may be allowed with sufficient separation distance (see Bed Separation Distances, below).

Bed Separation Distances

Minimum bed separation distances:

- 5 ft. separation for end-to-end system beds (measured pipe to pipe) if elevation difference is 1 ft. or less.
- 10 ft. separation for end-to-end system beds (measured pipe to pipe) if elevation difference is greater than 1 ft. but less than 3 ft.
- 20 ft. separation for end-to-end beds if elevation difference is greater than 3 ft.
- 20 ft. separation for side-to-side beds regardless of elevation difference.

Minimum Bed Separation	
Elevation Differential	Required Bed Separation
12 in. or less	5 ft.
12 in. – 36 in.	10 ft.
> 36 in.	20 ft.
Side-to-Side	20 ft.

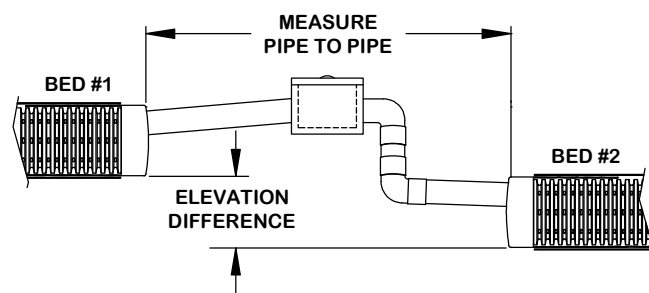

Multiple Bed Distribution, continued

Multiple Bed Basic Serial Distribution – equal linear footage of Advanced Enviro-Septic® pipe in each bed

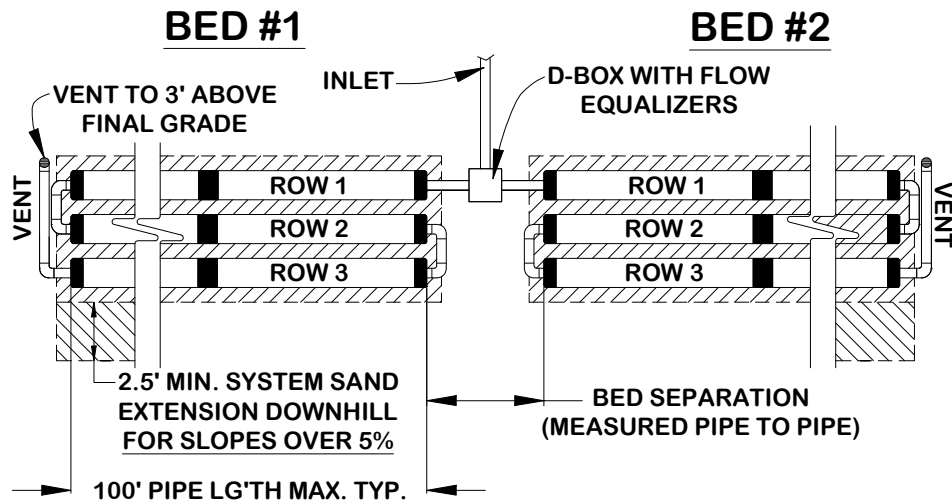

Note: This Multiple Bed Basic Serial distribution configuration may be used in all soil types. See previous page for Minimum Bed Separation distances.

Bed separation for Side-to-Side layout

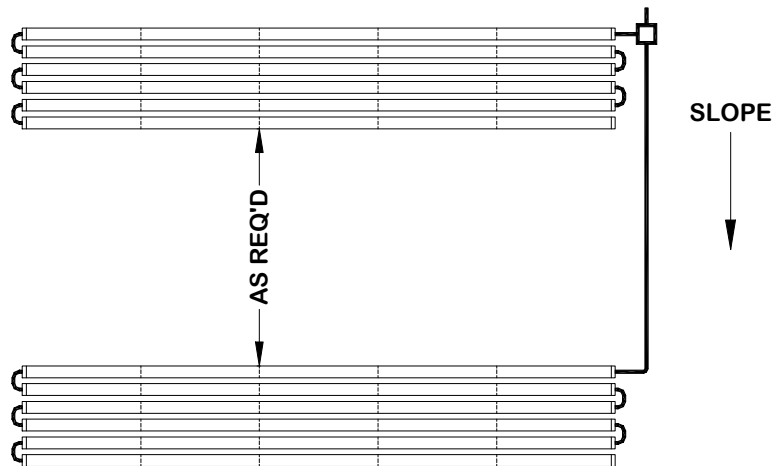

Unique Site Solutions for any soil type

Introduction

The configurations described in this Section may be used to accommodate site constraints. These configurations may be used in any soil type (perc rates 1-120 mpi).

Angles

Angled configurations generally have one or more specific bends, but the rows should follow the contour of the site. Rows are angled by bending pipes or through the use of offset adapters. The following layouts may be used in any soil type.

Note: A 10 ft. length of Advanced Enviro-Septic® pipe may be bent up to 90°.

SYSTEM LAYOUT AT 90°

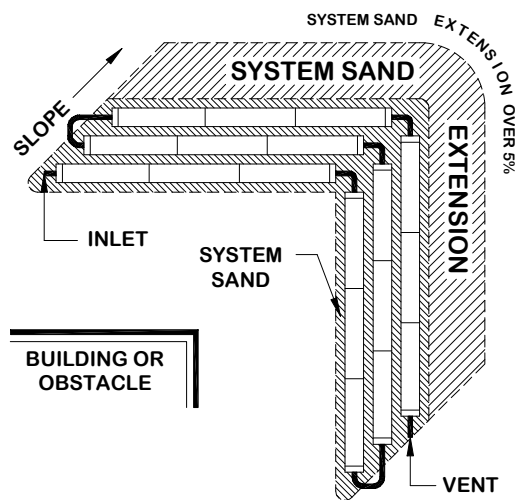

SYSTEM CURVED ABOUT RADIUS

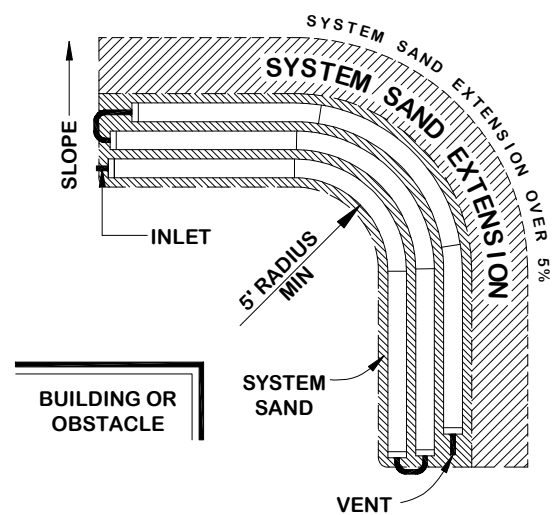

Curves

Curved configurations work well around structures, setbacks, and slopes. Multiple curves can be used if dictated by the contour of the site.

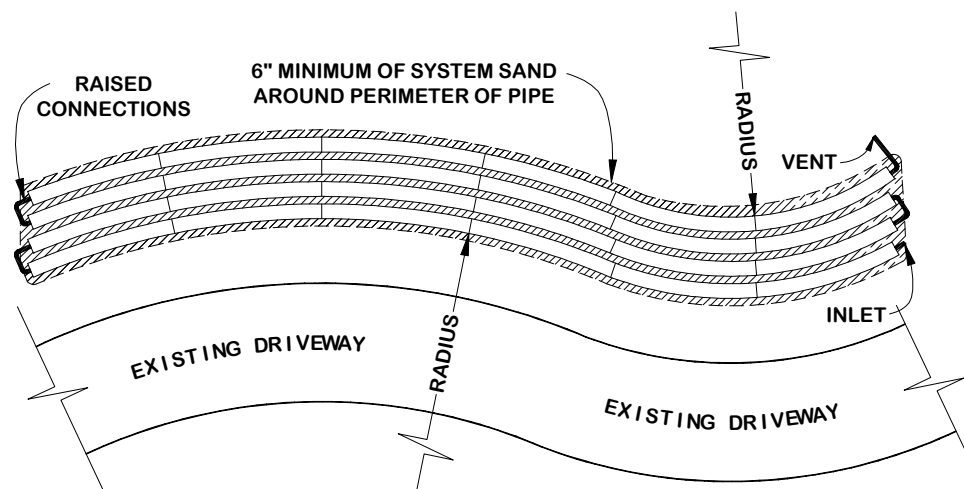

Unique Site Solutions Restricted to use in Perc Rates 1-60 MPI

Introduction

The configurations described in this Section may be used to accommodate site constraints. **The use of the configurations described on this page is restricted to use in perc rates 1-60 mpi.**

Total Linear Feet Requirement

- Each Section or bed must have at least the minimum linear feet of pipe.
- A Section or bed may exceed the minimum linear length.
- Rows within a Section or bed may vary in length to accommodate site constraints.
- All beds must contain at least two rows.

Row Lengths Less than 30 ft.

In general, we recommend that all Advanced Enviro-Septic® rows are from 30 ft. to 100 ft. in length. However, if site constraints require a system design with ANY row shorter than 30 ft., the design must be a D-Box or Combination Serial Configuration. Row lengths less than 30 ft. require a D-box and at least two serial Sections. Use of a design with any row with a length less than 30 ft. can only be used in soils with perc rates 1-60 mpi.

Shortest Pipe Row Length (ft.)	Minimum Sections Req'd.
10	3
15-25	2

Trapezoids & Irregular Shapes

The system shown below has a unique shape in order to meet horizontal setbacks or adapt to site constraints such as buildings, lot lines, wooded areas or surface waters. The use of the “trapezoidal,” “trapezoidal combination” and “wedge-shaped” configurations is limited to soils with perc rates 1-60 mpi.

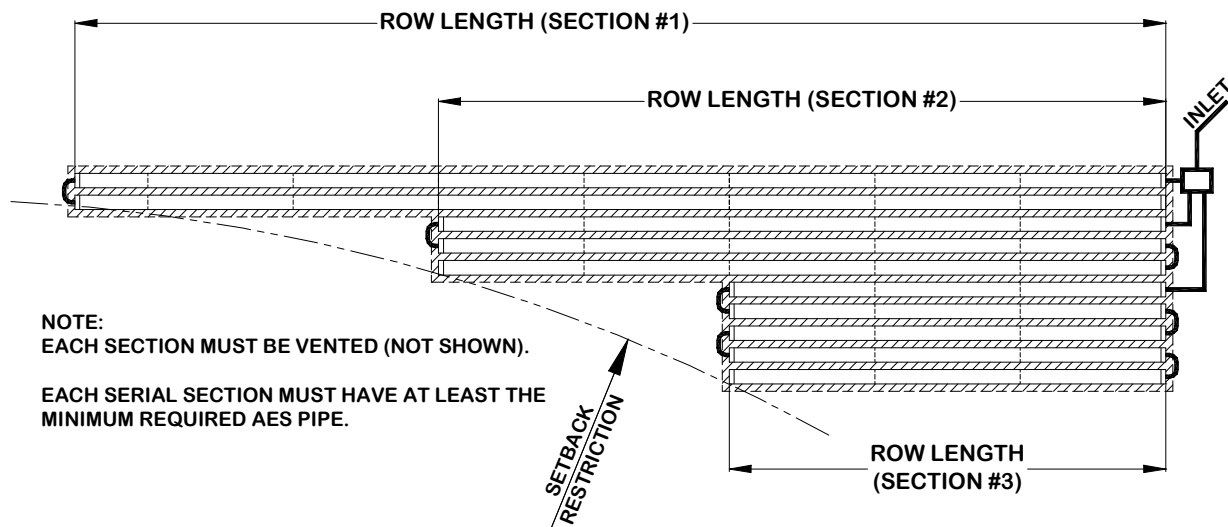

Vertical Placement of the System

Configuration Not Requiring Side-Slope Tapering

If all parts of the system, including cover material, are at or below original grade, the system will not require side-slope tapering.

Configuration Requiring Side-Slope Tapering

- If any part of the system (including soil cover) is above original grade, the system will require side-slope tapering as illustrated below.
- Side-slope tapering is used to blend the system into the terrain, making it both less susceptible to erosion and less noticeable.
- Side-slope tapering is to be a minimum of 2:1 slope; in a sloping system, side-slope tapering on the down-slope side is to be a minimum of 3:1 slope.
- Refer to Section I, System Sand and Fill Material Specifications, p. 33 for more information about the specifications for the soil material to be used to construct side-slopes.
- Also refer to Section L, Final Grading, pp. 39-40.

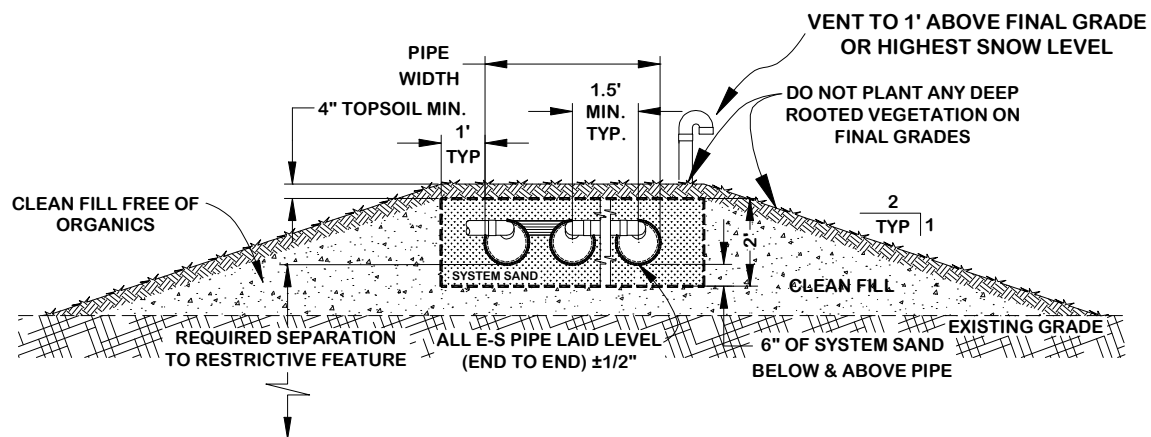

Site Preparation

Refer to Section K, Installation & Construction Procedures, pp. 36-38 for instructions regarding site preparation for systems requiring side-slopes.

System Slope and Site Slope

The percentage of slope in all illustrations refers to the slope of the Advanced Enviro-Septic® System, not the existing terrain. The slope of the Advanced Enviro-Septic® System and the existing terrain are not required to be equal. Refer to Table B, p. 8 for maximum system and site slopes for various soil types.

Systems Sloping 5% or less

In a system sloping 5% or less, the Advanced Enviro-Septic® rows are centered on the System Sand bed as shown in the illustration on p. 11.

Orientation of the Pipes on the System Sand Bed, System Slope > 5%

Systems Sloping more than 5%

In a system sloping greater than 5%, the Advanced Enviro-Septic® rows are positioned with 6 in. of System Sand on the up-slope side with the remaining System Sand extending beyond the pipe on the down-slope side. In systems sloping greater than 5%, there must be a minimum of 3 ft. of System Sand beyond the last down-slope row of pipe. Any part of the System Sand bed that is more than 6 in. away from the Advanced Enviro-Septic® pipe, called "System Sand Extension" needs to be a minimum of 6 in. deep, as shown in the illustration below.

Section view of grouped upslope orientation for a system sloping over 5%:

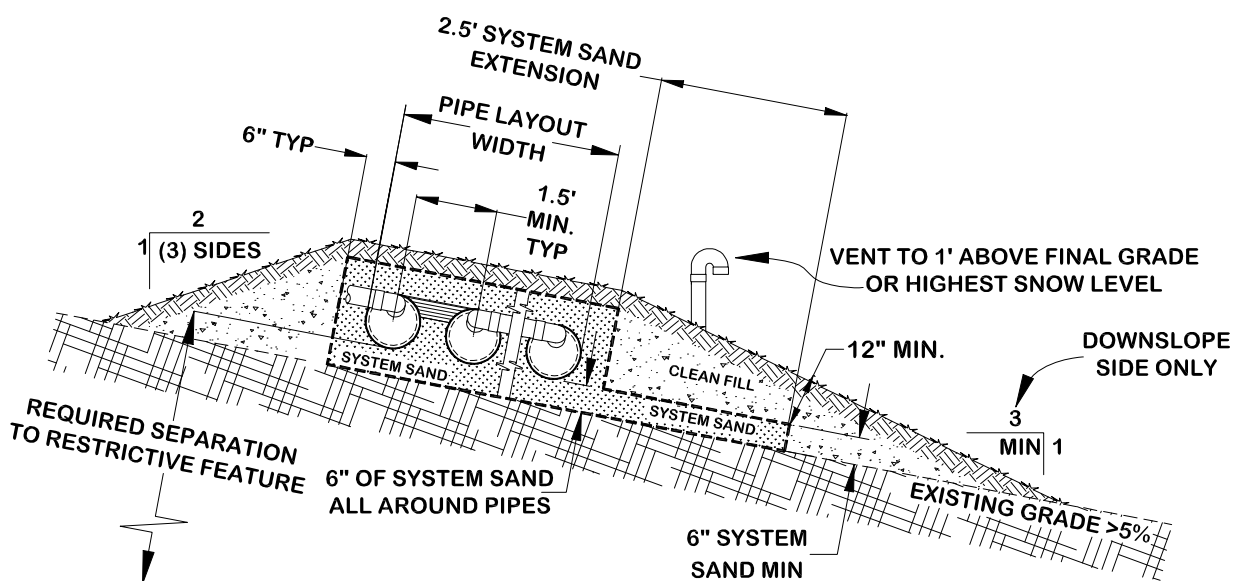

Multiple slopes in one bed

Multiple slopes within a single Advanced Enviro-Septic® System are easily accommodated. If any portion of the system slopes greater than 5%, pipes are grouped on the up-slope side of the System Sand bed, and there must be at least 3 ft. of System Sand beyond the last Advanced Enviro-Septic® pipe row on the down-slope side. This configuration is limited to use in soils with perc rates of 1 – 60 mpi.

Section E
Design Criteria for Kansas

Center-to-Center Spacing of Rows

- Center-to-center spacing of Advanced Enviro-Septic® rows is a minimum of 1.5 ft.
- Center-to-center spacing is measured from the center of one pipe to the center of the pipe in the next row.
- Center-to-center spacing of 1.5 ft. results in the minimum of 6 in. of System Sand between each row of Advanced Enviro-Septic® pipe.

Daily Design Flow Calculations Commercial

Non-residential Systems will use 1 ft. of AES pipe for every 2 gpd of daily design flow: $\text{Daily Design Flow (gal/day)} \div 2 = \text{Minimum AES pipe (ft.)}$

Daily Design Flow Calculations Residential

Residential Daily Design Flows are calculated at 150 gallons per day per bedroom.

D-Box Manifold

- A D-box manifold is utilized to equalize flow.
- Flow equalizers should be used on all D-box outlets.
- Unused D-box outlets must be covered, plugged or mortared.
- This configuration is especially useful when designing for large daily design flows. See "Velocity Reduction," this Section, p. 26.

Distribution box manifold is used to divide flow evenly to multiple beds or sections:

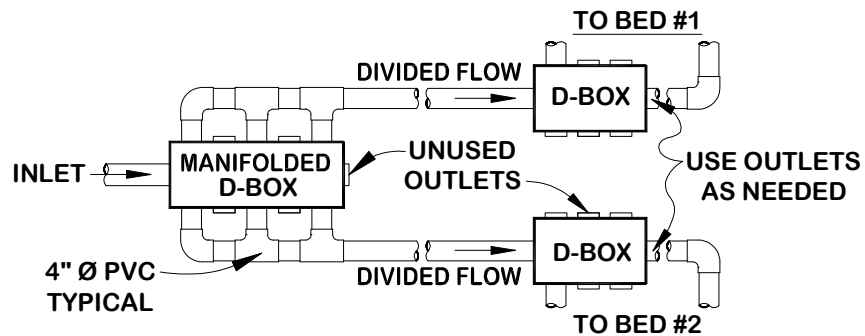

Note: Utilizing every other outlet will provide room for required piping and allow for easier installation. Install flow equalizers on all used outlets.

Design Criteria for Kansas, continued

End-to-End Preferred Over Side-to-side If site conditions permit, end-to-end system bed configurations are preferable to side-to-side system bed configurations. See illustrations on p. 16.

Filters

- All septic tanks must be equipped with baffles to reduce the amount of solids exiting the tank and entering the Advanced Enviro-Septic® System.
- Effluent filters are not recommended by Presby Environmental, Inc. due to their tendency to clog, which cuts off the oxygen supply that is essential to the functioning of the Advanced Enviro-Septic® System.
- If you are required to use an effluent filter in a gravity fed system due to state or local requirements, the effluent filter selected must allow the free passage of air to ensure the proper functioning of the system.

Garbage Disposals

- If a garbage disposal is utilized, we recommend that the required liquid capacity of the septic tank be increased by 50%.
- Multiple compartment septic tanks or multiple tanks are preferred.
- If a garbage disposal is used, the septic tank will likely require more frequent pumping (see Operation & Maintenance, Section M, p. 41).

Horizontal Separation Distances Minimum horizontal separation distances (also called “set-backs”) must comply with state and/or local requirements. Horizontal separation distances are measured from the outermost edge of the System Sand.

Interceptor Drains

- Interceptor Drains, if used, must be upslope of the AES System and a minimum of 10 ft. away from all AES pipe.
- Advanced Enviro-Septic® pipe is excellent for use in constructing interceptor drains.

Longer Advanced Enviro-Septic® Systems Recommended All Advanced Enviro-Septic® Systems are recommended to be designed and installed as long and narrow as practical for the site. This is especially important in soils with perc rates greater than 60 mpi.

Minimum Number of Rows All beds must have at least 2 parallel rows.

Minimum and Maximum Row Lengths To maintain efficient effluent cycling within the Advanced Enviro-Septic® pipe, the maximum row length is 100 ft. and the minimum row length is 30 ft. (For acceptable designs with row lengths shorter than 30 ft., refer to Section D, System Configurations, p. 18.)

Design Criteria for Kansas, continued

Orientation of Pipes on System Sand Bed

For Advanced Enviro-Septic® Systems sloping less than or equal to 5%, the System Sand extends horizontally a minimum of 6 in. beyond the outer perimeter of the Advanced Enviro-Septic® pipes, with the pipes centered on the System Sand bed.

For systems sloping from over 5% up to 25%, the Advanced Enviro-Septic® rows are positioned (grouped) 6 in. from the up-slope edge of the System Sand bed. A minimum of 3 ft. of System Sand is required beyond the last down-slope row. Any part of the System Sand bed more than 6 in. away from the Advanced Enviro-Septic® pipe needs to be a minimum of 6 in. deep.

Refer to Table B, p. 8 for slope limitations

See illustrations on p.11.

Pipe Length (Minimum) Required

- Residential Systems: Total minimum length of Advanced Enviro-Septic® pipe is 50, 60 or 70 ft. per bedroom depending on the soil's perc rate. Refer to Table B, p. 8.
 - Commercial Systems: A minimum of 1 ft. of AES pipe is required per every 2 gallons of design daily flow. Contact Presby Environmental for high strength effluent recommendations.
-

Pumped System Requirements

- Pumped systems to gain elevation are allowed with the Advanced Enviro-Septic® System.
- The use of pressure distribution with the Advanced Enviro-Septic® System is **not** permitted.
- Systems incorporating pumps to gain elevation must use differential venting (see Section G, Venting Requirements, pp. 28-31) and velocity reduction (see p. 26) to control liquid flow.
- Pump dose volume is limited to 40 gpm for Basic Serial Systems.
- When flow is divided by a D-box, equalizers are required and dose volume is limited to 20 gpm per flow equalizer.

Reference: See Section F, Pumped System Requirements, p. 27.

Design Criteria for Kansas, continued

Replacement Area Not Required

In the unlikely event that an Advanced Enviro-Septic® System needs to be replaced...

- It can be reinstalled in the same location, eliminating the need for a replacement system reserve area.
- All unsuitable material must be removed prior to replacement system construction.
- Dispose of hazardous materials properly.
- Permits are sometimes required for system replacement; contact the appropriate approving authority to determine if a permit is required.

Note: Attempt Rejuvenation procedures **before** replacing the system. This simple process can often restore normal system function in a matter of days. Refer to Section N, Rejuvenation and Expansion, p. 42 and call PEI for technical assistance.

Required Depth Vertical Separation Distances

- In order for a site to be acceptable for an AES System, there must be at least 9 in. of in situ unsaturated soil. Refer to Section H, Site Selection, p. 32.
 - The minimum separation distance between the Advanced Enviro-Septic® pipe and the Seasonal High Water Table (SHWT) is 18 in.
 - The minimum separation distance between the AES pipe and ledge, bedrock or impermeable soils (perc rates greater than 120 mpi) is 18 in.
 - The required depth to meet vertical separation distances is measured from the bottom of the Advanced Enviro-Septic® pipe.
-

Row Elevations

For sloping sites, elevations must be provided on the construction plan for each Advanced Enviro-Septic® row in the system. This is referred to as an “elevation table.”

Row Orientation

Advanced Enviro-Septic® rows must be laid level to within 1 in. end-to-end and preferably will be approximately parallel to the contour of the site.

Septic Tank and D-Box Elevations

The outlet of a septic tank or D-box must be set at least 2 in. above the highest inlet to the first Advanced Enviro-Septic® row, with the connecting pipe slope not less than 1% (approximately 1/8 in. per foot.)

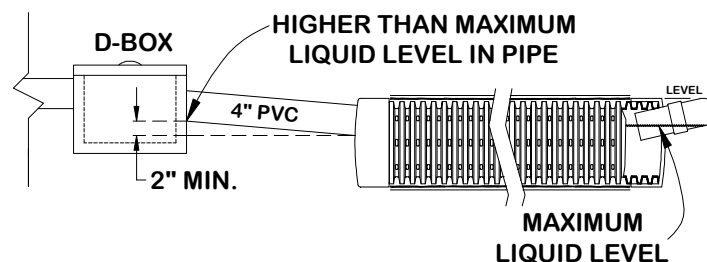

Design Criteria for Kansas, continued

Side-slope Tapering

Side-slope tapering is to be a minimum of 2:1.

Sloping Sites

- The percentage of slope in all system illustrations refers to the slope of the Advanced Enviro-Septic® System, not the existing terrain.
 - The system slope and the site slope do not have to be the same.
 - Maximum site slope is 33% and maximum system slope is 25%; permissible slope varies depending on the soil's perc rate (see Table B, p. 8).
 - The site and/or the system may contain more than one slope, provided the maximum allowed site and system slopes are not exceeded. If any system slope within the system exceeds 5%, this configuration is limited to use in soils with perc rates 1-60 mpi.
 - If the system slopes more than 5%, the Advanced Enviro-Septic® pipes will be placed 6 in. from the up-slope edge of the System Sand bed. The System Sand bed will extend a minimum of 3 ft. past the last row on the down-slope side.
 - The width of the System Sand bed will sometimes need to be increased in order to achieve the minimum required 3 ft. past the most down-slope row of pipe. This is referred to as a "System Sand Extension."
 - Remember that any portion of the System Sand bed that is more than 6 in. away from the Advanced Enviro-Septic® pipes only needs to be a minimum of 6 in. deep.
-

System Sand Bed Area (Minimum)

For Residential and Commercial Systems, refer Soil Loading Rates (SLR), Table A on p. 8. $\text{Daily design flow (gpd)} \div \text{SLR} = \text{Minimum System Sand bed area (sq. ft.)}$

System Sand Bed Vertical Dimensions

The overall height of an Advanced Enviro-Septic® System measures 24 in. (including System Sand, not including fill or cover materials):

- 6 in. of System Sand below the Advanced Enviro-Septic® pipe;
 - 12 in. diameter of the Advanced Enviro-Septic® pipe; and
 - 6 in. of System Sand above the Advanced Enviro-Septic® pipe.
 - The System Sand Extension is any portion of the System Sand bed that is more than 6 in. from the outermost perimeter of any Advanced Enviro-Septic® pipe; this portion of the System Sand bed only needs to be a minimum of 6 in. deep. (See illustrations on p. 11 and p. 20.)
-

System Sand Specifications

It is **critical** to the proper functioning of the Advanced Enviro-Septic® System that the proper amount and type of System Sand be installed. Refer to Section I, System Sand and Fill Material Specifications, p. 33.

Ten Foot Increments Work Best

It is easier if row lengths are designed in 10 ft. increments since Advanced Enviro-Septic® pipe comes in 10 ft. sections. However, if necessary, the pipe is easily cut to **any** length to meet site constraints. Using 5 ft. increments minimizes waste of pipe material.

Design Criteria for Kansas, continued

Topographic Position Requirement

The topographic position of the site must be convex, hill slope, or flat. No onsite system may be located on concave slopes that concentrate surface or ground water flows unless up-slope terrain is sufficiently altered or interceptor drains are used to redirect water away from the system. Refer to Section H, Site Selection, p. 32 for additional information and tips about selecting the right location for an Advanced Enviro-Septic® System.

Velocity Reduction

- Velocity reducers are needed when there is excessive slope between the septic tank and the Advanced Enviro-Septic® System.
 - A velocity reducer at the system inlet is required if the velocity of the fluid entering the Advanced Enviro-Septic® pipes would create enough turbulence to disrupt the natural settling of suspended solids within the Advanced Enviro-Septic® pipes.
 - D-boxes with baffles or a velocity reducing tee are commonly used for velocity reduction.
 - Velocity reduction is required in pumped systems. Refer to Section F, Pumped System Requirements, p. 27.
-

Venting Requirements

All Advanced Enviro-Septic® Systems require venting. Pumped systems require differential venting. Refer to Section G, Venting Requirements, pp. 28-31.

Wastewater Strength

All design criteria in this Manual assume “usual” or “typical” domestic wastewater strength. Designers should take any unusual wastewater characteristics into consideration when designing a system.

Where wastewater strength is high or wastes are unusual, additional Advanced Enviro-Septic® pipe is recommended. Please contact us for technical assistance.

Water Purification Systems

- Water purification systems and water softeners should **not** discharge into an Advanced Enviro-Septic® System.
 - This “backwash” does not require treatment and the additional flow may overload the system. Designs should include an alternative means of dispersal.
 - If there is no alternative means of disposing of this backwash, then the system will need to be “oversized.” Calculate the total amount of backwash in gpd, multiply by 2, and add this amount to the daily design flow and increase septic tank size accordingly.
 - Water purification systems and water softeners require regular routine maintenance; consult and follow the manufacturer’s recommendations.
-

Section F
Pumped System Requirements

Introduction	Pumped systems supply effluent to the Advanced Enviro-Septic® System using a pump and D-box when site conditions do not allow for a gravity system.
Differential Venting	<p>All pumped systems must use differential venting.</p> <p><u>Reference:</u> See Section G, Venting Requirements, pp. 28-31.</p>
D-Box	All pumped systems require a D-box. See “Velocity Reduction,” below.
Velocity Control	The rate at which effluent enters Advanced Enviro-Septic® pipe must be controlled. Excessive effluent velocity can disrupt solids that settle in the Advanced Enviro-Septic® pipes.
Velocity Reduction	<ul style="list-style-type: none">• Effluent must never be pumped directly into Advanced Enviro-Septic® pipe.• A D-box or tank must be installed between the dose tank (sometimes called a “pump chamber”) and Advanced Enviro-Septic® pipe to reduce effluent velocity.• Force mains must discharge into a D-box with a velocity reducer such as a baffle or tee.
Dose Volume	<ul style="list-style-type: none">• Pump volume per dose must be no greater than 1 gallon times the total length of all rows.• Pump dosing must be a minimum of 4 times per day; 6-8 cycles per day are recommended.• The dosing cycle should provide at least one hour between doses.• Pump dose volume is limited to 20 gpm per equalizer.
Basic Serial Distribution Limit	Systems with Basic Serial distribution are limited to a maximum dose rate of 40 gallons per minute when no flow equalizers are used.
Combination and Multiple-Bed Distribution Limit	<ul style="list-style-type: none">• All Advanced Enviro-Septic® Systems with Combination Serial distribution or Multiple Bed distribution must use flow equalizers in D-box outlets.• Since most flow equalizers are limited to a maximum of 20 gpm, each bed or Section of Combination Serial distribution is limited to a maximum of 20 gallons per minute (gpm) per flow equalizer.• Do not place a flow equalizer on the D-box outlet to the vent.

Section G Venting Requirements

General Rule

- Adequate ventilation is **essential** to the proper functioning of the Advanced Enviro-Septic® System.
 - Vent openings must be located to ensure the unobstructed flow of air through the entire Advanced Enviro-Septic® System.
 - The low vent inlet must be a minimum of 1 ft. above final grade (or as necessary to be above expected snow level).
-

When to Vent

- High and low vents are **required** for **all** systems.
 - The roof (house) vent is the “high vent” in gravity systems.
 - One 4 in. diameter low vent is required for every 1,000 ft. of Advanced Enviro-Septic® pipe.
 - A single 6 in. diameter low vent may be installed instead of three 4 in. diameter vents.
 - The diameter of the vent manifold must match the vent stack diameter.
-

Differential Venting

- Differential venting is the use of high and low vents in a system.
 - High and low vent openings must be separated by a minimum of 10 vertical ft.
 - The high and low vents should be of the same capacity.
 - Roof vent diameter must be a minimum of 3 in., 4 in. diameter is recommended. If the roof vent is less than 3 in., an additional high vent is recommended.
 - Sch. 40 PVC or equivalent should be used for all high vents.
 - Vents extending more than 3 ft. above grade must be anchored.
-

Vent Locations

Vent locations depend upon the type of system. For ease of illustration, most illustrations show high and low vents on opposite ends of the field; however, high and low vents may be installed on the same end of the field as long as the 10 ft. differential between high and low vents are maintained. Refer to illustrations on next page.

Gravity Systems

- A low vent through an offset adapter is installed at the end of each row, Section or Basic Serial bed. A vent manifold may be used to connect the ends of multiple Sections or rows.
- **The house (roof) vent functions as the high vent** as long as there are no restrictions or other vents between the low vent and the house (roof) vent.

Pumped Systems

- A low vent is installed through an offset adapter at the end of each row, Section or Basic Serial bed.
 - A high vent is installed through an unused D-box outlet.
 - Alternatively, the low vent may be attached to the D-box and the high vent may be attached to the end of the last Advanced Enviro-Septic® row. If this configuration is used in cold climates, the D-box must be insulated to prevent it from freezing.
-

Differential Venting for Pumped Systems

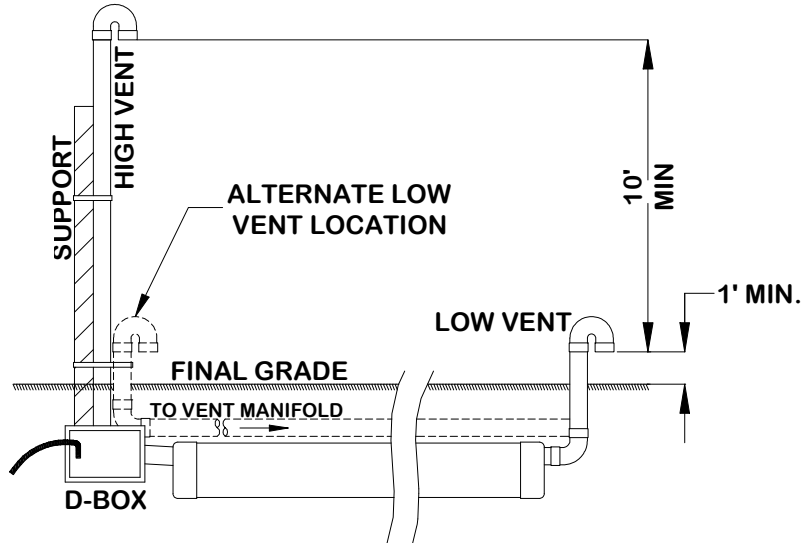

Proper gravity system vent configuration

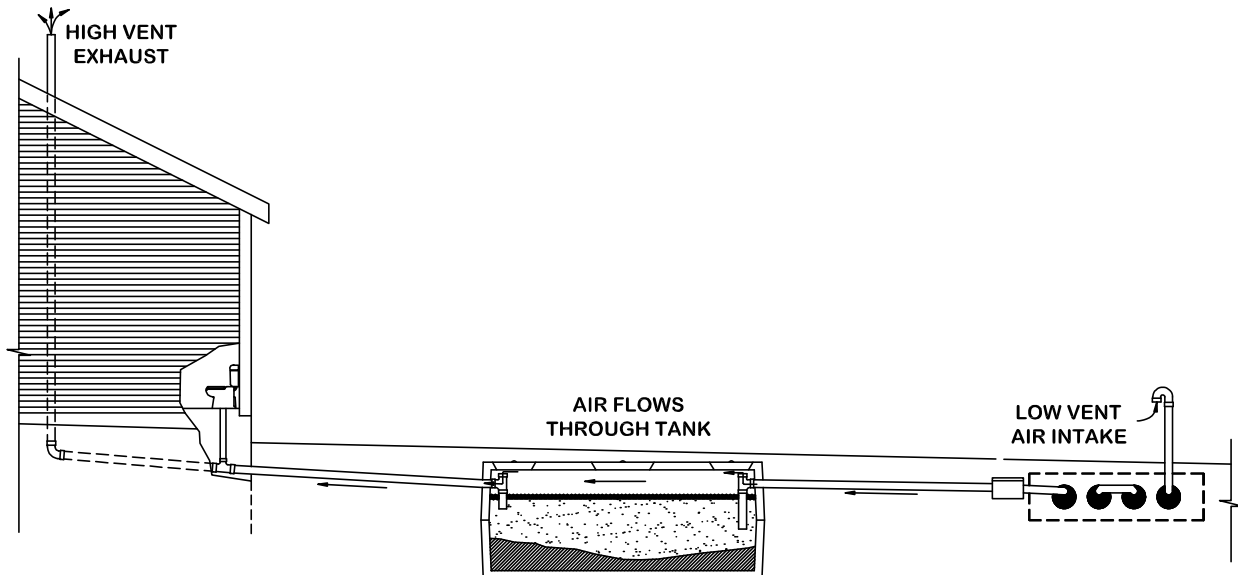

Air flow is established by the High Vent's chimney effect, which draws air into the Low Vent, through the Advanced Enviro-Septic® pipes, through the septic tank and exhausting through the roof vent.

Venting Requirements, continued

Vent Manifolds A vent manifold may be incorporated to connect the ends of a number of Sections or rows of Advanced Enviro-Septic® pipe to a single vent opening. See illustration on p. 21.

Vent Piping Slope Vent piping should slope downward toward the system to prevent moisture from collecting in the pipe and blocking the passage of air.

Remote Venting If site conditions do not allow the vent pipe to slope toward the system, or the owner chooses to utilize remote venting for aesthetic reasons (causing the vent pipe not to slope toward the system), the low point in the vent line must be drilled creating several $\frac{1}{4}$ in. holes to allow drainage. This procedure may **only** be used if the vent pipe connecting to the system has:

- A **high point** that is above the highest point of the Advanced Enviro-Septic® row or D-box that it is connected to; and,
- A **low point** opened for drainage which is above the SHWT. (See illustration below.)

REMOTE DIFFERENTIAL VENTING

(NOT TO SCALE)

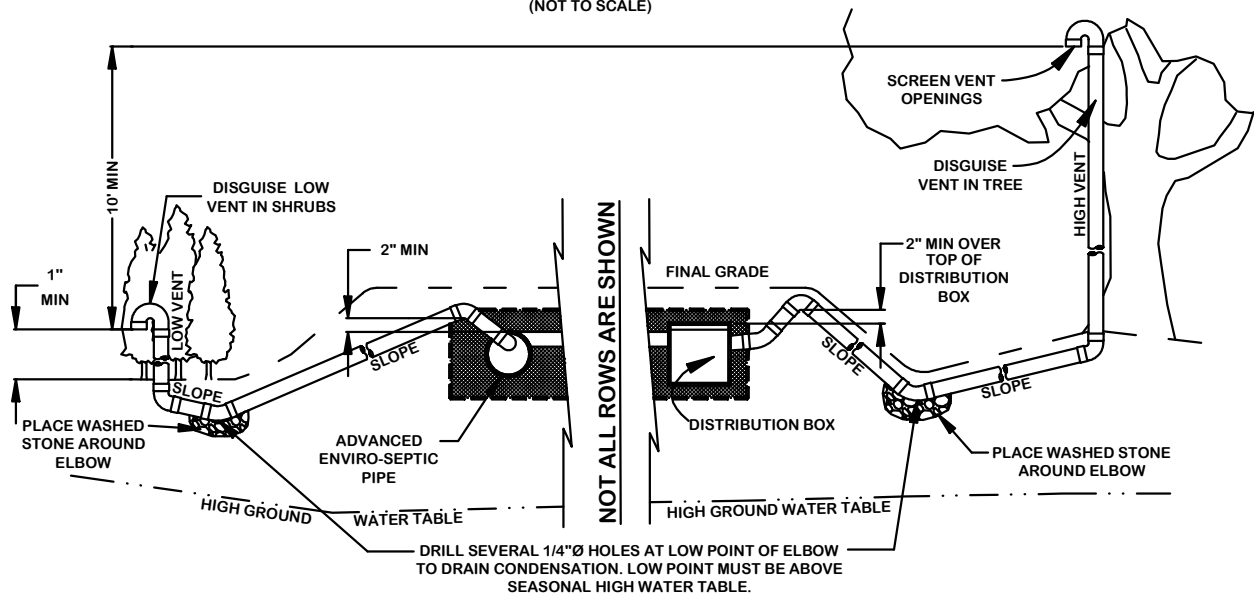

By-Pass Venting By-Pass Venting is an alternative method of venting for use with pumped systems only, see illustration on the following page.

BY-PASS VENTING

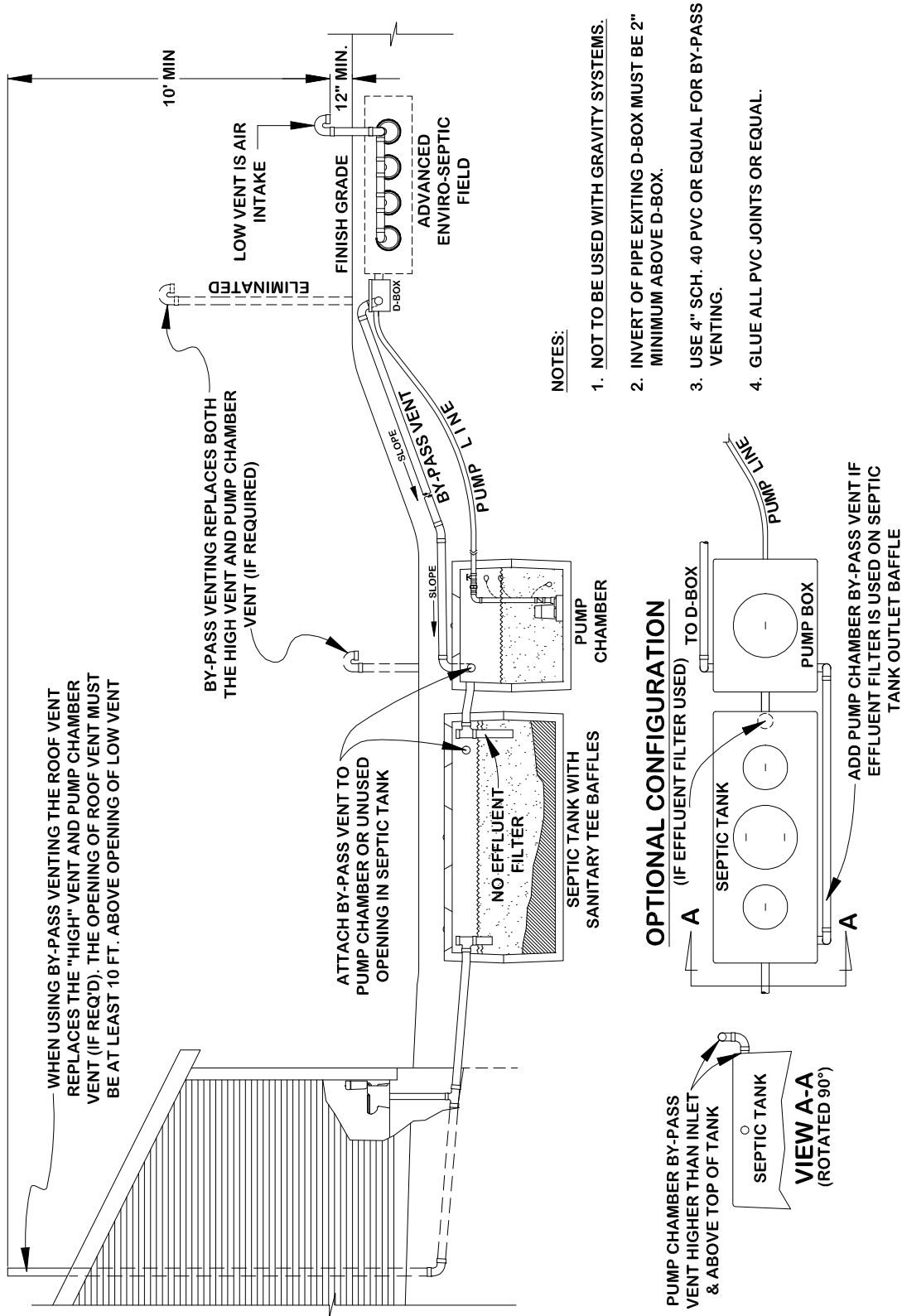

Section H
Site Selection

Determining Site Suitability	In order to decide if a particular site is suitable for an Advanced Enviro-Septic® System, measure the distance down from existing grade to the highest layer of SHWT, ledge, bedrock or impermeable soil in the soil horizon in the proposed system site and a 50 ft. perimeter. There must be a minimum of 9 in. of unsaturated in situ soil, or the distance required by Kansas regulations (whichever is greater), in order to install an Advanced Enviro-Septic® System
Topography	Locate systems on convex, hill slope or level locations that do not concentrate surface flows. Avoid swales, low areas, or toe-of-slope areas that may not provide sufficient drainage away from the system.
Surface Water Diversions	Surface water runoff must be diverted away from the system. Diversions must be provided up-slope of the system and designed to avoid ponding. Systems must not be located in areas where surface or groundwater flows are concentrated.
Dispersal Area	Systems must be located where adjacent soils in the proposed system location and a 50 ft. perimeter are suitable for dispersing water away from the system.
Containment	Systems should not be located where structures such as curbs, walls or foundations might adversely restrict the soil's ability to transport water away from the system.
Hydraulic Loading	Systems should not be located where lawn irrigation, roof drains, or natural flows increase water loading to the soils around the system.
Access	Systems should be located to allow access for septic tank maintenance and to at least one end of all Advanced Enviro-Septic® rows in case Rejuvenation is needed.
Rocky or Wooded Areas	Use caution when preparing a rocky or wooded site, since removal of trees, stumps, roots, rocks, etc. may alter the soil's ability to accept water. No trees or shrubs should be located within 10 ft. of the system to prevent root infiltration.
Reserve Area	Since Advanced Enviro-Septic® preserves the characteristics of the underlying soils, it is not necessary to designate a reserve area for a replacement system.

Section I
System Sand & Fill Material Specifications

System Sand

The System Sand that surrounds the Advanced Enviro-Septic® pipes is an **essential** component of the system. It is **critical** that the correct type and amount of System Sand is used when constructing the system. System Sand must be coarse to very coarse, clean, granular sand, free of organic matter. It must adhere to **all** of the following percentage and quality restrictions:

- No stones over ¾ in. in diameter
- Percentage Restrictions (by total weight):
 - 35% maximum retained by a #10 sieve
 - 40-90% retained by a #35 sieve
 - Fines Quality Restrictions: A maximum of 2% of total sand may pass through a #200 sieve
- ASTM C-33 sand may be acceptable for use as System Sand providing that no more than 2% can pass a #200 sieve.

System Sand is placed a minimum of 6 in. below all Advanced Enviro-Septic® pipes, a minimum of 6 in. above the Advanced Enviro-Septic® pipes, a minimum of 6 in. between Advanced Enviro-Septic® rows, and a minimum of 6 in. horizontally around the perimeter of the Advanced Enviro-Septic® pipes.

**Sand Fill or
Fill Material**

Sand fill is to be used to raise the elevation of the system in order to meet the required separation distance from the SHWT or other restrictive feature. It is also used in constructing side-slope tapering. This sand shall be clean, bank run sand, free of topsoil, organic matter or debris and containing no stones larger than 6 in.. No more than 15% by weight of this sand shall pass through a #100 sieve and no more than 5% shall pass through a #200 sieve.

Naturally-occurring soils removed when excavating the site may be used for constructing side-slope tapering, provided the soil contains no organics, stones larger than 6 in., stumps or other debris.

Note: System Sand may be used in place of sand fill.

**Topsoil
(a.k.a. “Loam”)**

Suitable earth cover, similar to the naturally occurring soil at the site and capable of sustaining plant growth, is required as the uppermost layer over the entire system (and side-slope tapering). The topsoil layer should be a minimum of 4 in. deep and should be immediately seeded or mulched in order to prevent erosion.

Section J
Preparing for Installation

Avoid Compaction Avoid compaction of the soils in the area receiving System Sand, the side-slope tapering and the area down-slope of the proposed system. Materials and equipment must not be stored or transported over the receiving soils.

- Excavation Procedures**
- Locate machinery up-grade or alongside of the proposed system area when excavating, avoiding the system area.
 - Excavate the receiving area with a toothed bucket only. Do not excavate the receiving area with a finish bucket because this will compact or smear the soil.
 - A minimum of 6 in. of System Sand or sand fill must be installed prior to equipment traveling above the system to avoid compaction and destruction of soil structure.
-

Avoid Drying Soil Dispersal area soils must not be allowed to dry. Sun or extended dry air conditions may alter soil structure. System Sand must be installed immediately following excavation of the receiving area.

- Avoid Precipitation and Erosion**
- Do not excavate the system receiving area immediately after, during or prior to precipitation.
 - Install sediment/erosion control barriers prior to beginning excavation to protect the system from possible surface water flows during construction.
 - Warm, dry weather conditions are ideal for system installation. Check the weather forecast and schedule installation accordingly.
-

Avoid Frozen Soil If possible, do not excavate the soils in the system area during frozen conditions. If you have no alternative but to install the system in cold weather, be prepared to work quickly, do not allow excavated soil to cool, and install System Sand immediately. Cover the System Sand with a protective layer of insulation or hay/straw and canvas if overnight temperatures may be below freezing during the installation process.

Avoid Wet Soil Conditions Do not excavate in and around the system area when the soil is wet. If soil forms a rod 1/8 in. or less in diameter when rolled with the fingers, or if it does not crumble easily, it contains too much moisture to be worked.

Install Sand System Sand or sand fill must be installed immediately following excavation of the system area. If it is not, repeat the "Excavation Procedures" above.

Construction Equipment Construction equipment may travel across the system area only after the installation of a minimum of 6 in. of sand fill or System Sand. If at all possible, keep equipment off the System Sand.

Preparing for Installation, continued

Component Handling

- Keep mud, grease, oil, etc. away from all components.
 - Avoid dragging pipe through wet or muddy areas.
 - Store pipe on high and dry areas to prevent surface water and soil from entering the pipes or contaminating the fabric prior to installation.
 - The outer fabric of the Advanced Enviro-Septic® pipe is ultra-violet stabilized; however, this protection breaks down after a period of time in direct sunlight. To prevent damage to the fabric, cover the pipe with an opaque tarp or store indoors.
-

Stake Out System Location

- Locate and stake out the System Sand bed (including System Sand extension area if needed), and areas impacted by side-slope tapering on the site according to the approved plan.
 - Double-check that all set-back requirements are met. Remember, horizontal set-backs are measured from the outermost edge of the System Sand bed.
 - Confirm that the site complies with the parameters in Section H, Site Selection, p. 32.
-

Section K
Installation & Construction Procedures

**Critical
Reminder
Prevent
Soil
Compaction**

It is critical to keep excavators, backhoes, and other equipment off the excavated or tilled surface under and around where the treatment system will be located. Before installing the System Sand, excavation equipment should be operated around the bed perimeter and not on the bed itself. During all stages of installation, avoid compacting soil adjacent to the bed as much as possible.

**Tree Stump
Removal**

- Remove all tree stumps and the central root system below grade by using a backhoe or excavator with a mechanical “thumb” or similar extrication equipment, lifting or leveraging stump in a manner that minimizes soil disturbance.
 - Do not locate equipment within the limits of the system area.
 - Avoid soil disturbance, relocation, or compaction.
 - Avoid mechanical leveling or tamping of dislodged soil.
 - Fill all voids created by stump or root removal with System Sand.
-

**Raking and
Tilling
Procedures**

All areas receiving System Sand and side-slope tapering **must** have the organic layer (grass, leaves, forest litter, etc.) removed. If a backhoe/excavator is used to till the site, fit it with chisel teeth and till the site. The backhoe/excavator must remain outside of the proposed system location, including the entire System Sand bed area and all areas that will be impacted by side-slope tapering.

- For systems installed in soils with perc rates from 1 to 60 mpi , remove all organics and topsoil (O & A soil horizons) in the footprint of the dispersal area prior to installing System Sand.
 - For systems installed in soils with perc rates from 61-120 mpi with the bottom of the System Sand bed at the same approximate elevation as original grade, remove the organics, leave the topsoil in place and till it. Mix 6 in. of System Sand with the tilled topsoil to create a transition layer. This will prevent ponding at the interface of System Sand and underlying soil.
-

**Stone and
Organic Material
Removal**

While tilling, remove all stones larger than 6 in., stumps, roots, grass, brush and other organic matter or debris from the excavated system site. Refer to Tree Stump Removal, above, for proper procedures for removing stumps.

Note: It is not necessary for the soil of the system site to be smooth when the site is prepared.

Installation Procedures, continued

Install System Sand and/or Fill Immediately After Excavation

- To protect the tilled area (System Sand bed area and area impacted by side-slope tapering) from damage by precipitation, System Sand or sand fill should be installed immediately after tilling.
 - When installing the System Sand, work off either end or the uphill side of the system to avoid compacting soil (see "**Critical Reminder**" at the beginning of this section).
 - When installing sand, keep at least 6 in. of sand between the vehicle tracks and the tilled soil of the site.
 - Tracked construction equipment should not travel over the installed system area until at least 1 ft. of cover material is placed over the Advanced Enviro-Septic® pipes.
 - Construction equipment with wheels/tires should not travel over the installed system area until at least 18 in. of cover material is placed over the Advanced Enviro-Septic® pipes.
-

Row installation sequence

1. Install a minimum of 6 in. of System Sand to the elevation where the bottom of Advanced Enviro-Septic® pipes will be, and install the sand on side-slope tapering to allow machinery movement around the perimeter of the system. Rake the System Sand where the Advanced Enviro-Septic® pipes will be installed so it is as level as possible before placing pipes on the System Sand. This will make it easier to level the pipe rows.
 2. Locate Advanced Enviro-Septic® rows horizontally to tie points on site.
 3. Locate Advanced Enviro-Septic® rows vertically using a laser level or transit. Lift or lower the pipes at couplings using a hand shovel and adding or removing System Sand as necessary.
 4. Drop System Sand along each row of couplings being careful to avoid moving the rows.
 5. Add or remove System Sand along rows to level. The rows may be raised by straddling them and pushing additional System Sand below the pipes with your feet. A hand shovel may be scraped along the System Sand below the pipes to remove a small amount if needed.
 6. Re-check horizontal and vertical locations. Re-check that pipes are level to within 1 in. end-to-end.
 7. Add System Sand between and around the Advanced Enviro-Septic® pipes, leaving the uppermost surface of the pipe exposed to allow for system inspection (if required by local approving authority).
-

D-Box Installation

It is essential that the D-box remain level after installation in order to ensure even distribution to the all pipes within the system. Be sure D-boxes are placed level on undisturbed soil, compacted sand, pea gravel base, or concrete pad. Take care when backfilling that the D-box remains level.

Level Tolerances

Use a laser level or transit to install the pipes level within 1 in. end-to-end. Out-of-level pipe installation may affect system performance. Variations beyond a total of 1 in. are **not acceptable**.

Installation Procedures, continued

Row Spacers

Sand may be used to keep pipe in place while covering, but simple tools may also be constructed for this purpose. An example is shown below.

Caution: Remove all tools used as row spacers before final covering.

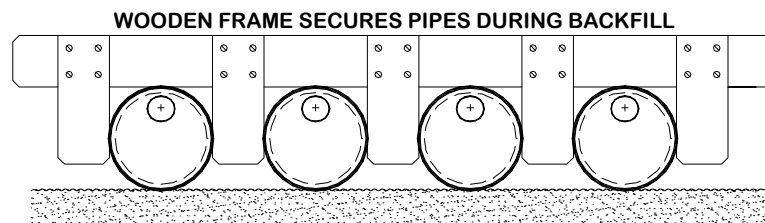

Connect Rows Using Raised Connections

Raised connections consist of offset adapters, PVC pipe, and 90° elbows. They enable greater liquid storage capacity within the pipes and increase the bacterial surfaces being developed. Use raised connections to connect the rows of the Advanced Enviro-Septic® System.

Correct Placement of Raised Connections

It is essential to the proper functioning of the system that the ends of the Raised Connections extend 2 in. to 4 in. into the Advanced Enviro-Septic® pipe. If the ends are not at least 2 in. into the pipe, they may become dislodged during backfilling. If the ends extend more than 4 in. into the pipe, this may cut off the flow of oxygen to the system. Refer to illustration below.

The top of the Raised Connections should be level with the top of the Advanced Enviro-Septic® pipe as shown below.

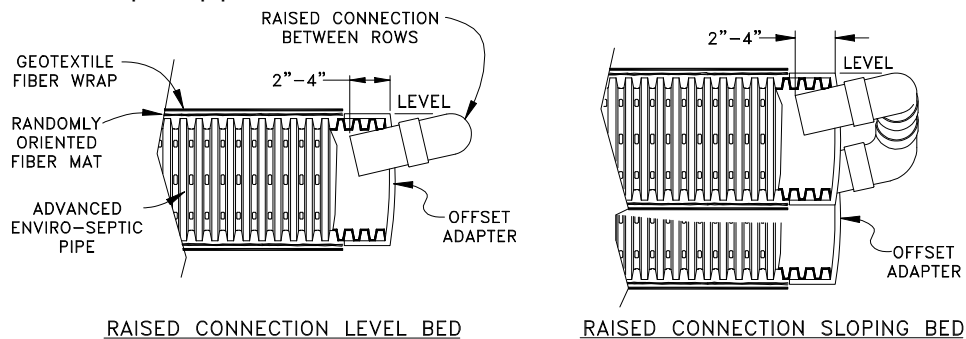

Install System Sand

- Spread System Sand between the rows.
- Straddle each row of pipe and walk heel-to-toe its entire length, ensuring that System Sand fills all void spaces beneath the Advanced Enviro-Septic® pipe.
- Finish spreading System Sand to the top of the pipes for inspection purposes (if required in your area).
- Confirm that all rows of pipe are level to within 1 in. end-to-end.
- After inspection (if required) proceed to backfilling and final grading.

Section L Final Grading

Side-Slope Tapering

To prevent erosion, all Advanced Enviro-Septic® Systems with any part of the system (including cover material) above original grade require side-slope tapering on each side beyond the outer edge of the System Sand bed, tapering to a 2:1 slope.

See Section I, p. 33 for fill material specifications.

Install Remaining 6 in. of System Sand

After the installed system has been inspected (if required by local approving authority), install 6 in. of System Sand above the pipes. DO NOT install any barrier materials on top of the System Sand.

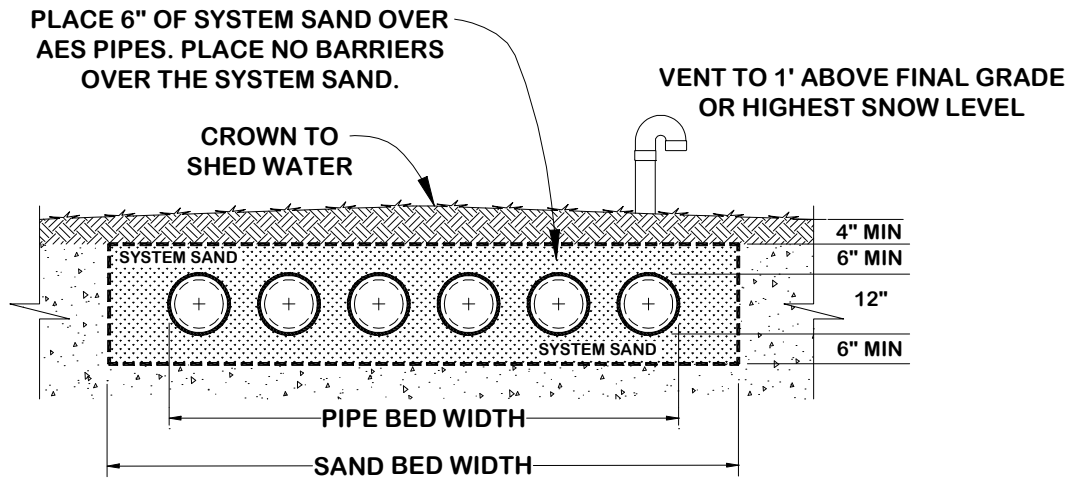

Final Grading

Final grading of the entire site should redirect surface water flows so that they do not collect in the system bed area. The system bed must slope or have a crown to ensure that surface water runoffs do not collect on the system. Systems should not be located where lawn irrigation, roof drains, or natural flows increase water loading to the soils around the system.

ABOVE GROUND - LEVEL

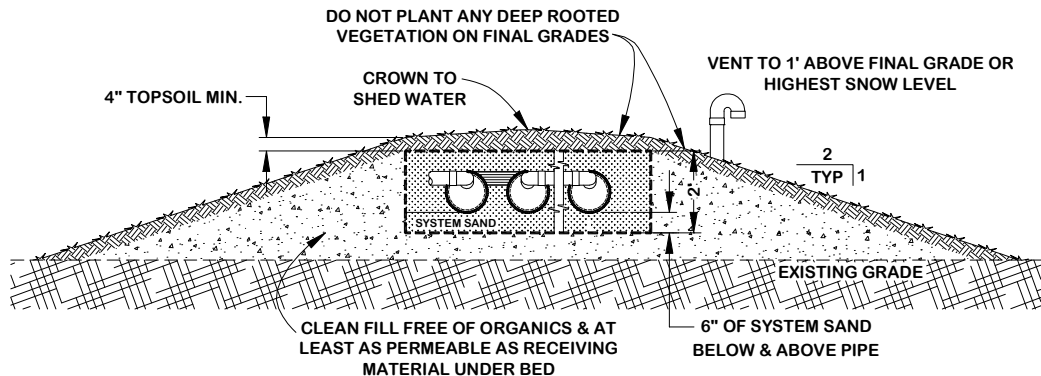

Final Grading, continued

Erosion control Construct and maintain surface diversions, grading, silt fence, seeding and mulching to minimize concentration of surface water flows and erosion.

Cover requirements A minimum of 4 in. of topsoil (loam) capable of supporting plant growth is required over the System Sand or sand fill.

Mulch or Seed Immediately apply mulch or seed with grass, wildflowers or other shallow-rooted native vegetation to prevent erosion of the system bed.

What not to Plant No trees or shrubs should be located on or within 10 ft. of the system perimeter (including side-slope tapering) to prevent roots from growing into and damaging the system. If the system includes a perimeter drain, there should be no trees or shrubs planted closer than 10 ft. from the location of the perimeter drain. Do not plant gardens for human consumption in the vicinity of the wastewater treatment system.

Section M Operation & Maintenance

Proper use

The Advanced Enviro-Septic® Wastewater Treatment System requires minimal maintenance provided the system is not subjected to abuse. An awareness of proper use and routine maintenance will guarantee system longevity. All system owners are encouraged to obtain a copy of our Owner's Manual, which is available from our website, www.PresbyEnvironmental.com.

System abuse conditions

The following conditions constitute system abuse:

- Liquid in high volume (excessive number of occupants, excessive use of water in a short period of time, leaking fixtures, whirlpool tubs, hot tubs, water softening equipment or additional water discharging fixtures if not specified in system design).
- Solids in high volume (excessive number of occupants, paper products, personal hygiene products, garbage disposals or water softening equipment if not specified in system design)
- Antibiotic medicines in high concentrations
- Cleaning products in high concentrations
- Fertilizers or other caustic chemicals in any amount
- Petroleum products in any amount
- Latex and oil paints
- System suffocation (compacted soils, barrier materials, etc.)

Special Note: Presby Environmental, Inc., and most regulatory agencies do not recommend the use of septic system additives.

System maintenance/ Pumping of the Septic Tank

- Inspect the septic tank at least once every two years under normal usage.
 - Pump the tank when surface scum and bottom sludge occupy one-fourth or more of the liquid depth of the tank.
 - If a garbage disposal is used, the septic tank will likely require more frequent pumping.
 - After pumping, inspect the septic tank for integrity to ensure that no groundwater is entering it. Also check the integrity of the tank inlet and outlet baffles and repair if needed.
 - Inspect the system to ensure that vents are in place and free of obstructions.
 - Effluent filters are not recommended because of their tendency to clog and cut off oxygen to the system. If a filter is used, it will require diligent maintenance and cleaning to prevent it from becoming clogged. Follow filter manufacturer's maintenance instructions and inspect filters frequently.
-

Site maintenance

It is important that the system site remain free of shrubs, trees, and other woody vegetation to within a minimum of 10 ft. of the system, including the entire System Sand bed area, and areas impacted by side-slope tapering and perimeter drains (if used). Roots can infiltrate and cause damage or clogging of system components.

If a perimeter drain is used, it is important to make sure that the outfall pipes are screened to prevent animal activity. Also check outfall pipes regularly to ensure that they are not obstructed in any way.

Section N
Rejuvenation and Expansion of Advanced Enviro-Septic® Systems

Introduction This section provides an overview of bacteria rejuvenation and explains how to expand existing systems. These procedures may only be used with Advanced Enviro-Septic® Systems; it is difficult or impossible to rejuvenate other systems. The local approving authority must be contacted and permits obtained if required prior to Advanced Enviro-Septic® System rejuvenation, expansion, or replacement. Please contact PEI at 800-473-5298 for technical assistance before attempting rejuvenation procedures.

What is Bacteria Rejuvenation? Bacteria rejuvenation is the return of bacteria to an aerobic state. Flooding, improper venting, alteration or improper depth of soil material cover, use of improper sand instead of System Sand, introduction of chemicals or medicines, and a variety of other conditions can contribute to converting bacteria in the Advanced Enviro-Septic® pipe from an aerobic to an anaerobic state. This conversion severely limits the bacteria's ability to effectively treat effluent, as well as making it more difficult for wastewater to pass through.

How to Rejuvenate Bacteria System bacteria are "rejuvenated" when they return to an aerobic state. By using the following procedure, this can be accomplished in most systems without costly removal and replacement.

1. Determine and correct the problem causing the bacteria conversion.
2. Drain the system by excavating one end of each row and removing the offset adapters.
3. If foreign matter has entered the system, flush the pipes.
4. Safeguard the open excavation.
5. Guarantee a passage of air through the system.
6. Allow pipes to dry for a minimum of 72 hours. When the System Sand around the pipes returns to its natural color, this is an indication that the conversion to aerobic conditions has taken place.
7. Re-assemble the system to its original design configuration. As long as there is no damage to the Advanced Enviro-Septic components, the original components may be reused.

Note: Contact Presby Environmental, Inc., for more detailed instructions before attempting to rejuvenate an Advanced Enviro-Septic® System.

System Expansion Advanced Enviro-Septic® Systems are easily expanded by adding equal lengths of pipe to each row of the original design, or by adding additional equal Sections, or by adding additional beds. Check with the appropriate approving authority to determine if a permit is required.

Reusable Components Advanced Enviro-Septic® components are not biodegradable and may be reused. In cases of improper installation it may be possible to excavate, clean, and reinstall all system components.

System Replacement If an Advanced Enviro-Septic® System requires replacement...

- Remove the existing components and contaminated sand
- If the soils under and around the system have not been compromised, replace in the same excavated location with new System Sand.
- If components are not damaged, they may be cleaned and reused.

Note: Permits may be required for system replacement.