

Advanced Enviro-Septic™ (AES) Treatment System

Ohio Design and Installation Manual



✓ Minimizes the Expense ✓ Protects the Environment ✓ Preserves the Site



Presby Environmental, Inc.
The Next Generation of Wastewater Treatment Technology

143 Airport Rd., Whitefield, NH 03598

Tel: 800-473-5298 Fax: (603) 837-9864

Email: info@presbyeco.com

www.PresbyEnvironmental.com

The information in this manual is subject to change without notice. We make a continual effort to improve our Manuals in order to ensure they are as complete, accurate and helpful as possible. Please confirm that this is the most recent and up-to-date version of this Manual by contacting us at (800) 473-5298 or visiting our website, www.presbyenvironmental.com

Your questions, suggestions and comments are welcome. Please contact us at:

Presby Environmental, Inc.
143 Airport Road
Whitefield, NH 03598
Phone: 1-800-473-5298 Fax: (603) 837-9864
Website: www.PresbyEnvironmental.com

IMPORTANT NOTICE: This Manual is intended ONLY for use in designing and installing Presby Environmental's Advanced Enviro-Septic™ Wastewater Treatment System.

The use of this Manual with any other product is prohibited.

The processes and design criteria contained herein are based solely on our experience with and testing of Enviro-Septic® and Advanced Enviro-Septic™. Substitution of any other large diameter gravelless pipe will result in compromised treatment of wastewater and other adverse effects.

**Advanced Enviro-Septic™ U.S. Patent Nos. 6,461,078; 5,954,451; 5,606,786; 6,899,359; 6,792,977 and 7,270,532 with other patents pending.
Canadian Patent Nos. 2,300,535; 2,185,087; 2,187,126 with other patents pending.**

**Enviro-Septic® is a registered trademark of Presby Environmental Inc.
Advanced Enviro-Septic™ is a pending trademark of Presby Environmental, Inc.**

**© Presby Environmental, Inc. May 2010
All Rights Reserved**

Table of Contents

Section	Title	Pages
A	Introduction	1-4
B	Advanced Enviro-Septic™ Components	5-7
C	Advanced Enviro-Septic™ System Sizing	8-9
D	System Configurations	10-25
E	General Design Criteria	26-31
F	Ohio State Specific Information	32-33
G	Design/Sizing Procedures & Examples	34-38
H	Pumped System Requirements	39
I	Perimeter Drains	40-41
J	Venting Requirements	42-46
K	Site Selection	47
L	System Sand and Fill Material Specifications	48
M	Preparing for Installation	49-50
N	Installation & Construction Procedures	51-54
O	Final Grading	55-56
P	Operation & Maintenance	57
Q	Rejuvenation & Expansion	58-59
Appendix A	System Installation Form	60
Appendix B	Installation Checklist	61-62
Appendix C	Inspection Report Form	63-64
	Glossary	65-68

Advanced Enviro-Septic™ Treatment System Ohio Design and Installation Manual

Section A, Introduction

What is Advanced Enviro-Septic™?	<p>Advanced Enviro-Septic™ (AES) is an innovative onsite Wastewater Treatment System that is passive, non-mechanical and does not use pressure distribution. The primary component is a large diameter perforated pipe that is installed in a bed of specified System Sand. The Advanced Enviro-Septic™ system is designed to purify wastewater that has received primary treatment in a septic tank and to disperse the treated wastewater into the underlying soils. The system is extremely versatile and can be designed in a variety of shapes and sizes, making it adaptable to virtually any residential or commercial application. The amount of pipe required and the size of the System Sand bed adjust in relation to the amount of daily design flow, the soil's characteristics and site constraints, ensuring effective treatment and adequate absorption into underlying soils.</p>
How Does Advanced Enviro-Septic™ work?	<p>By utilizing simple yet effective natural processes, the Advanced Enviro-Septic™ Treatment System treats septic tank effluent in a manner that prevents suspended solids from sealing the underlying soil, increases system aeration, and provides a greater bacterial area ("biomat") than conventional septic systems.</p>
Why is Advanced Enviro-Septic™ Better?	<p>The Advanced Enviro-Septic™ Treatment System retains solids in its pipe and provides multiple bacterial surfaces to treat effluent prior to its release into the soil. The continual cycling of effluent (the rising and falling of liquid inside the pipe) enhances bacterial activity. No other passive wastewater treatment system design offers this functionality. Our systems excel because they are more efficient, last longer, and have a minimal environmental impact.</p>
System Advantages	<ul style="list-style-type: none">• Provides superior treatment• Thoroughly tested to prove it works• Preserves the natural terrain• Cost-effective to construct and operate• Completely passive, requires no mechanical devices or electricity• Design versatility to adapt to virtually any site, any flow, any application• Quicker and easier to install• Quick system start-up makes it ideal for intermittent/seasonal properties• Enhanced function and longevity• Requires no special maintenance• Superior track record of reliability• Made using recycled plastic

Introduction, continued

Purpose	<p>The purpose of this Manual is to provide general information regarding the design criteria, installation procedures and use and care instructions for the Advanced Enviro-Septic™ Treatment System.</p> <p>The Advanced Enviro-Septic™ System is extremely versatile and, as a result, this Manual cannot possibly set forth every conceivable system configuration. We encourage you to contact our Technical Advisors, who will be happy to address any questions or concerns unique to your project or assist you in designing a system for special applications.</p>
Presby Environmental Standards	<p>All systems using the Advanced Enviro-Septic™ Treatment System must be designed and installed in compliance with the procedures and specifications described in this Manual. Exceptions to any requirements in this Manual require Presby Environmental, Inc. (PEI) approval.</p>
Conflicts Between State Rules & this Manual	<p>In the event of contradictions between this Manual and Ohio and/or local rules, PEI should be contacted for technical assistance.</p>
Certification Required	<p>PEI requires all Designers, Installers or Homeowners acting as their own designer or installer to be certified. Certification is obtained by completing the “Advanced Enviro-Septic™ Certification Course” presented by PEI or its sanctioned representative. We offer a variety of certification training options, including online webinars and DVDs. Please visit our website, www.PresbyEnvironmental.com.</p> <p>Special note: PEI highly recommends that all individuals involved in the approval, permitting or inspection process also complete a certification course.</p>
Technical Support	<p>PEI provides technical support free of charge to all individuals using our products or involved in the permitting process. For any questions about our products or the information contained in this Manual, please contact us at (800) 473-5298, send an email to info@presbyeco.com or visit our website, www.PresbyEnvironmental.com.</p>
Disclaimer	<p>The technical support staff at Presby Environmental, Inc. is committed to providing comprehensive product information and support via telephone, website and email at no cost to our customers. The assistance we are able to provide in this way is based on limited information and therefore should be considered general in nature. Accordingly, Presby Environmental, Inc. disclaims any liability whatsoever in connection with providing technical support.</p>

ADVANCED ENVIRO-SEPTIC™ WASTEWATER TREATMENT SYSTEM WITH BIO-ACCELERATOR™

**TEN STEPS OF WASTEWATER TREATMENT: ADVANCED ENVIRO-SEPTIC™
TREATS EFFLUENT MORE EFFICIENTLY TO PROVIDE LONGER SYSTEM LIFE
AND TO PROTECT THE ENVIRONMENT.**

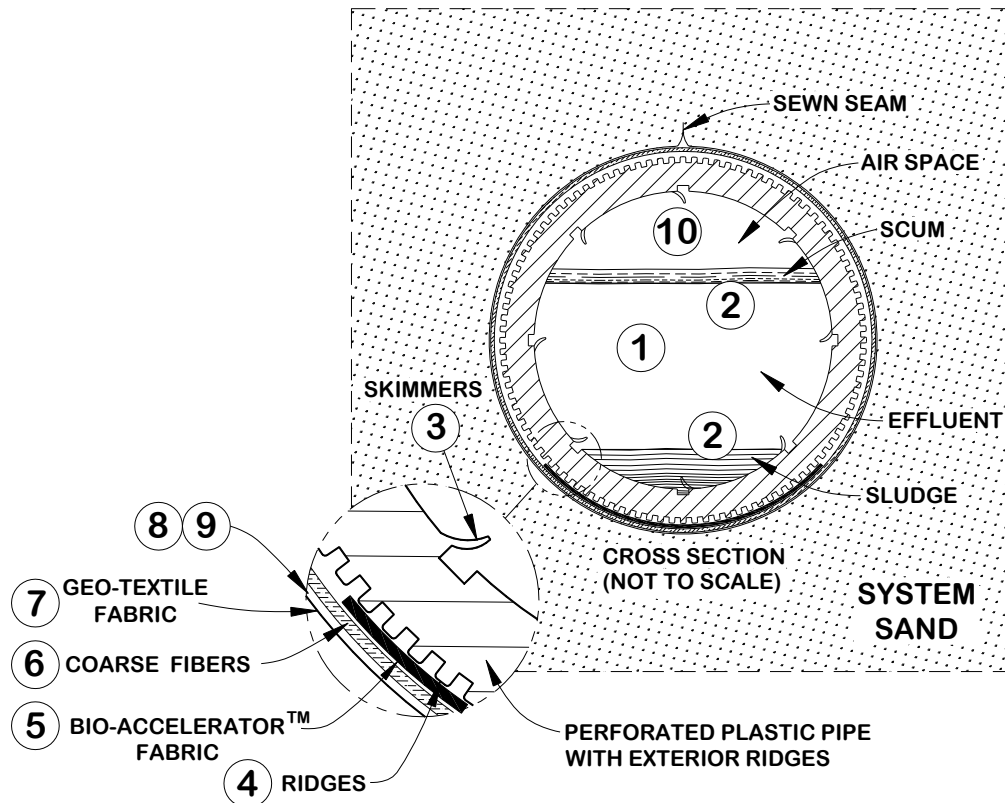

- STAGE 1:** WARM EFFLUENT ENTERS THE PIPE AND IS COOLED TO GROUND TEMPERATURE.
- STAGE 2:** SUSPENDED SOLIDS SEPARATE FROM THE COOLED LIQUID EFFLUENT.
- STAGE 3:** SKIMMERS FURTHER CAPTURE GREASE AND SUSPENDED SOLIDS FROM THE EXITING EFFLUENT.
- STAGE 4:** PIPE RIDGES ALLOW THE EFFLUENT TO FLOW UNINTERRUPTED AROUND THE CIRCUMFERENCE OF THE PIPE AND AID IN COOLING.
- STAGE 5:** BIO-ACCELERATOR™ GEO-TEXTILE FABRIC FILTERS ADDITIONAL SOLIDS FROM THE EFFLUENT, ENHANCES AND ACCELERATES TREATMENT, FACILITATES QUICK START-UP AFTER PERIODS OF NON-USE, PROVIDES ADDITIONAL SURFACE AREA FOR BACTERIAL GROWTH, PROMOTES EVEN DISTRIBUTION, AND FURTHER PROTECTS OUTER LAYERS AND THE RECEIVING SURFACES SO THEY REMAIN PERMEABLE.
- STAGE 6:** A MAT OF COARSE RANDOM FIBERS SEPARATES MORE SUSPENDED SOLIDS FROM THE EFFLUENT.
- STAGE 7:** EFFLUENT PASSES INTO THE GEO-TEXTILE FABRIC AND GROWS A PROTECTED BACTERIAL SURFACE.
- STAGE 8:** SAND WICKS LIQUID FROM THE GEO-TEXTILE FABRIC AND ENABLES AIR TO TRANSFER TO THE BACTERIAL SURFACE.
- STAGE 9:** THE FABRIC AND FIBERS PROVIDE A LARGE BACTERIAL SURFACE TO BREAK DOWN SOLIDS.
- STAGE 10:** AN AMPLIE AIR SUPPLY AND FLUCTUATING LIQUID LEVELS INCREASE BACTERIAL EFFICIENCY.

ADVANCED ENVIRO-SEPTIC™ SYSTEM DIAGRAM

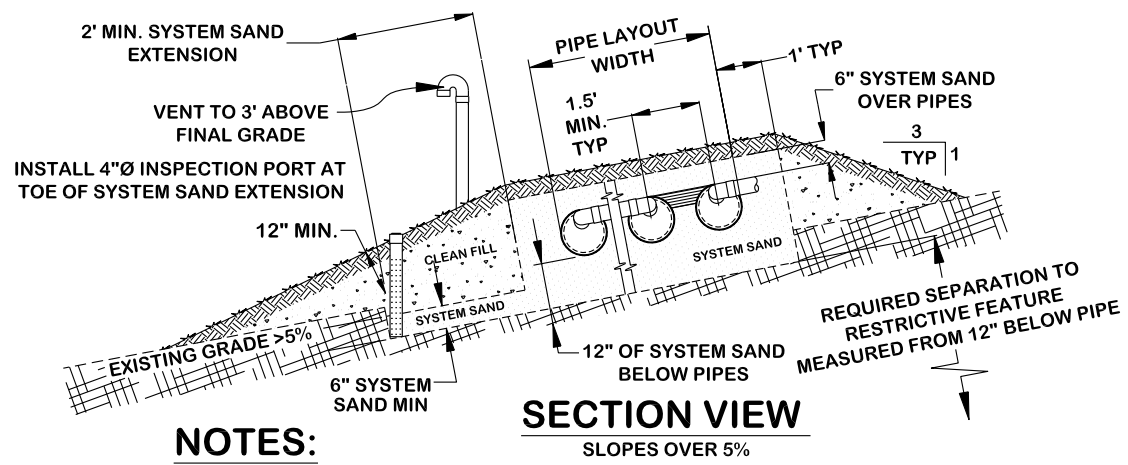
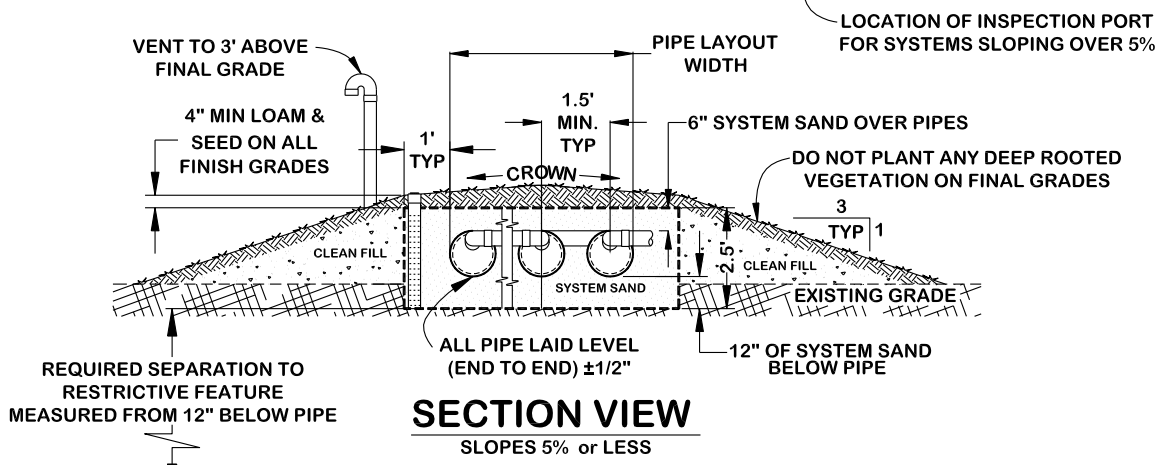
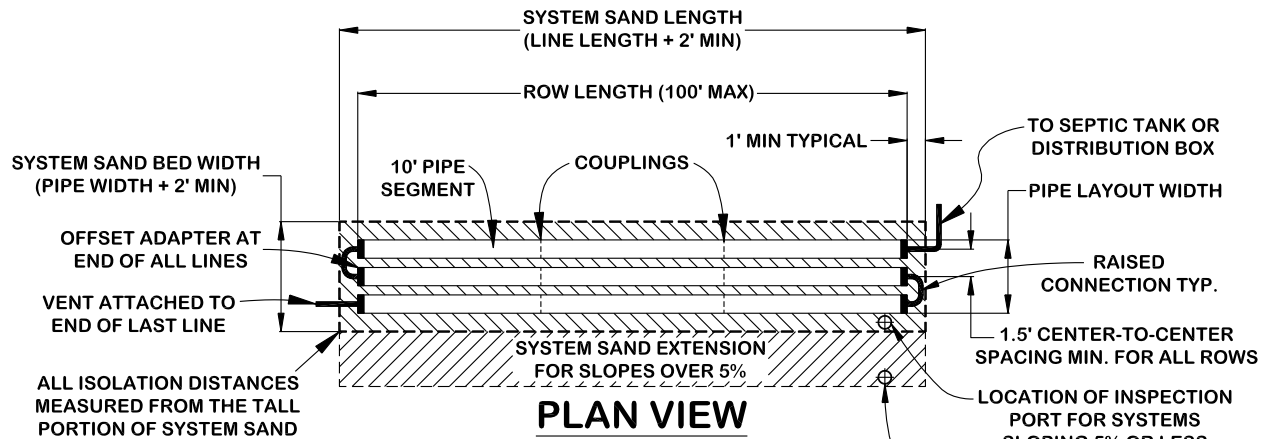

NOTES:

- ALL ROWS 1.5' SPACING MINIMUM.
- ROWS CENTERED IN SYSTEM SAND IF SLOPE IS 5% OR LESS.
- ROWS GROUPED TO UPSLOPE SIDE OF SYSTEM SAND IF SLOPE > 5%.
- VENTING REQUIRED FOR ALL CONFIGURATIONS.
- DIFFERENTIAL VENTING REQUIRED FOR ALL PUMP SYSTEMS.

Section B

Advanced Enviro-Septic™ System Components

Advanced Enviro-Septic™ Pipe



- Plastic pipe made with a significant percentage of recycled material
 - 10 ft. sections (can be cut to any length)
 - Ridged and perforated with skimmer tabs on interior
 - Bio-Accelerator™ on the bottom, exterior of pipe
 - Covered with a mat of randomly-oriented plastic fibers
 - Surrounded by a non-woven geotextile fabric stitched in place
 - Exterior diameter of 12 in.
 - Each 10 ft. section has a liquid holding capacity of approx. 58 gallons
 - Flexible enough to bend up to 90°
-

Offset adapter



An offset adapter is a plastic fitting with a 12 in. diameter and a hole designed to accept a 4 in. inlet pipe, raised connection, or vent pipe. The hole is to be in the twelve o'clock position.

Note: The hole in the offset adapter will accommodate Schedule 20 to 40 PVC.

Double offset adapter



A double offset adapter is a plastic fitting with a 12 in. diameter and two holes designed to accept a 4 in. inlet pipe, raised connection, vent or vent manifold piping, depending upon the particular requirements of the design configuration.

The two 4 in. holes are to be aligned in the 12 o'clock and 6 o'clock positions. The holes are positioned 1 in. from the outside edge of the double offset adaptor and 2 in. from each other.

Note: The holes in the double offset adapter will accommodate Schedule 20 to 40 PVC.

Coupling



A coupling is a plastic fitting used to create a connection between two pieces of Advanced Enviro-Septic™ pipe. The coupling features a snap-together locking device and ridges that are designed to fit over the ridges of the Advanced Enviro-Septic™ pipe, creating a quick and easy way to join pipe sections together easily and securely.

Advanced Enviro-Septic™ System Components, continued

Distribution Box A distribution box, also called a “D-Box,” is a device used to distribute effluent coming from the septic tank in a system that contains more than one section or more than one bed. D-Boxes with tees or baffles are also sometimes used for velocity reduction (see p. 31). D-Boxes come in various sizes and with a varying number of outlets. Concrete D-Boxes are preferred, some are made of plastic.

Flow equalizers (see below) are installed in the D-Box openings to equalize distribution; they help ensure equal distribution in the event that the D-Box settles or otherwise becomes out of level. Unused openings in D-Boxes are to be capped or mortared.

Flow Equalizers A flow equalizer is an adjustable plastic insert installed in the outlet holes of a distribution box to equalize effluent distribution to each outlet whenever flow is divided.

Raised Connection A raised connection is a PVC pipe configuration that is used to connect Advanced Enviro-Septic™ rows as shown below. We recommend using sewer and drain pipe for raised connections, Schedule 20 to 40 PVC can also be used.

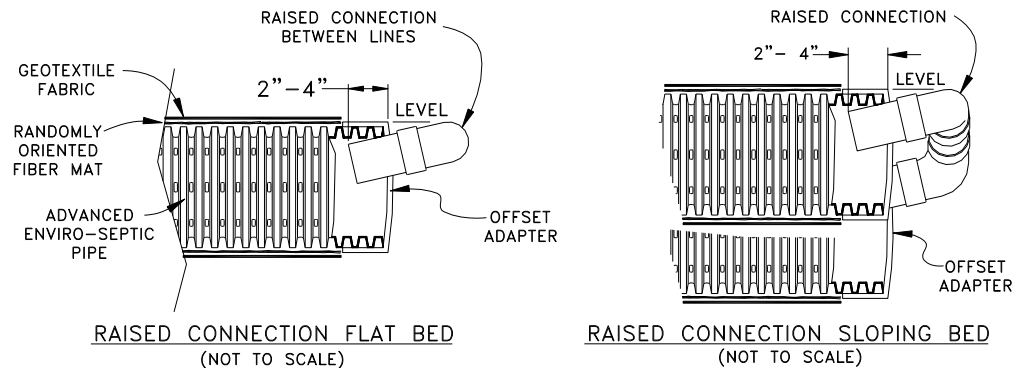

Inspection Ports An Inspection Port is a perforated PVC pipe with a removable cap that extends from the bottom of the System Sand and is accessible at final grade. Wrap PVC with fabric to protect against sand infiltration. A minimum of one Inspection Port is required per bed. Proper locations of inspection ports for level and sloping systems are shown below.

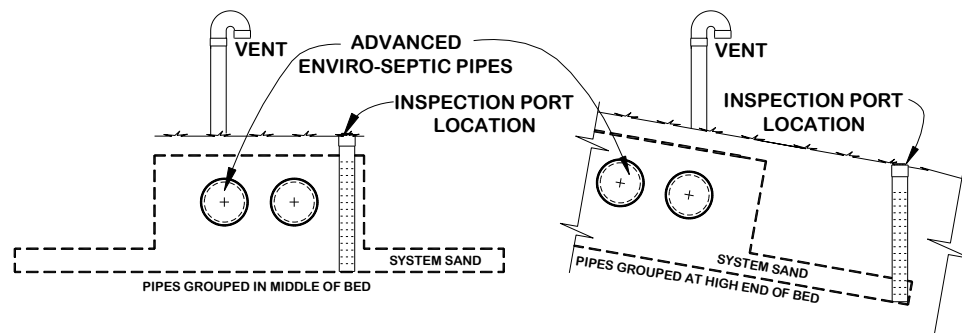

Advanced Enviro-Septic™ System Components, continued

Septic Tank

- The Advanced Enviro-Septic™ System is designed to treat effluent that has received “primary treatment” in a standard septic tank.
 - Septic tanks must be watertight and structurally sound to withstand burial pressure.
 - Unless specified by state/local regulations, the septic tank capacity should be:
 - No less than 1,000 gallons
 - Recommend using 2.5 times the Daily Design Flow
 - Septic tank capacity should be increased by 50% if a garbage disposal or basement ejector pump (pumping solids) is used.
 - Septic tanks used with the Advanced Enviro-Septic™ System must be fitted with inlet and outlet baffles in order to retain solids in the septic tank and to prevent them from entering the Advanced Enviro-Septic™ System.
 - Effluent filters are not recommended by Presby Environmental, Inc. due to their tendency to clog if not properly maintained, which restricts the oxygen supply that is essential to the functioning of the Advanced Enviro-Septic™ system.
 - If you are required to use an effluent filter in a gravity fed system due to state or local requirements, the effluent filter selected must allow the free passage of air to ensure the proper functioning of the system.
-

System Sand

The System Sand that surrounds the Advanced Enviro-Septic™ pipes is an **essential** component of the system. It is **critical** that the correct type and amount of System Sand is used when constructing the system. System Sand must be coarse to very coarse, clean, granular sand, free of organic matter. Manufactured sand is acceptable for System Sand. System Sand must meet one of the following specifications (sieve analysis from supplier recommended to confirm):

Option 1: OH Department of Transportation (DOT) Fine Aggregate Portland Cement Concrete (703.02) providing that no more than 2% can pass a #200 sieve (as determined by washing sample).

Option 2: ASTM C-33 (“concrete sand”) is acceptable for use as System Sand providing that no more than 2% can pass a #200 sieve (as determined by washing sample).

System Sand is placed a minimum of 12 in. below all Advanced Enviro-Septic™ pipes, a minimum of 6 in. above the Advanced Enviro-Septic™ pipes, a minimum of 6 in. between Advanced Enviro-Septic™ rows, and a minimum of 1 ft. horizontally around the perimeter of the Advanced Enviro-Septic™ pipes.

Component Handling & Storage

- Keep mud, grease, oil, etc. away from all components.
- Avoid dragging pipe through wet or muddy areas.
- Store pipe on high and dry areas to prevent surface water and soil from entering the pipes or contaminating the fabric prior to installation.
- The outer fabric of the Advanced Enviro-Septic™ pipe is ultra-violet stabilized; however, this protection breaks down after a period of time in direct sunlight. To prevent damage to the fabric, cover the pipe with an opaque tarp.

Section C - Advanced Enviro-Septic™ Sizing Tables

Table A - Infiltrative and Length Loading Rates:

Soil Characteristics			Bed Area using Infiltrative Loading Rate (ILR) gpd/sq.ft.	Length Loading Rate (LLR) gpd/ft.								
Texture	Structure			Site Slope %								
	Shape	Grade		0 – 4 % Infiltration Distance			5% – 9 % Infiltration Distance			10% & Over Infiltration Distance		
				6" To 12"	>12" to 24"	>24"	6" To 12"	>12" to 24"	>24"	6" To 12"	>12" to 24"	>24"
Very Coarse Sand, Coarse Sand, Sand, Loamy Coarse Sand, Loamy Sand	Single Grain	Structureless	1.6	4.0	5.0	6.0	5.0	6.0	7.0	6.0	7.0	8.0
Fine Sand, Very Fine Sand, Loamy Very Fine Sand	Single Grain	Structureless	1.0	3.5	4.5	5.5	4.0	5.0	6.0	5.0	6.0	7.0
Coarse Sandy Loam, Sandy Loam	Massive	Structureless	0.6	3.0	3.5	4.0	3.6	4.1	4.6	5.0	6.0	7.0
	Platy	Weak	0.5	3.0	3.5	4.0	3.6	4.1	4.6	4.0	5.0	6.0
		Moderate	-	-	-	-	-	-	-	-	-	-
	Prismatic, Blocky, Granular	Weak	0.7	3.5	4.5	5.5	4.0	5.0	6.0	5.0	6.0	7.0
Moderate, Strong		1.0	3.5	4.5	5.5	4.0	5.0	6.0	5.0	6.0	7.0	
Fine Sandy Loam, Very Fine Sandy Loam	Massive	Structureless	0.5	2.0	2.3	2.6	2.4	2.7	3.0	2.7	3.2	3.7
	Platy	Weak, Moderate	-	-	-	-	-	-	-	-	-	
	Prismatic, Blocky, Granular	Weak	0.6	3.0	3.5	4.0	3.3	3.8	4.3	3.6	4.1	4.6
		Moderate, Strong	0.8	3.3	3.8	4.3	3.6	4.1	4.6	3.9	4.4	4.9
Loam	Massive	Structureless	0.5	2.0	2.3	2.6	2.4	2.7	3.0	2.7	3.2	3.7
	Platy	Weak, Moderate	-	-	-	-	-	-	-	-	-	
	Prismatic, Blocky, Granular	Weak	0.6	3.0	3.5	4.0	3.3	3.8	4.3	3.6	4.1	4.6
		Moderate, Strong	0.8	3.3	3.8	4.3	3.6	4.1	4.6	3.9	4.4	4.9
Silt Loam	Massive	Structureless	0.2	2.0	2.5	3.0	2.2	2.7	3.2	2.4	2.9	3.4
	Platy	Weak, Moderate	-	-	-	-	-	-	-	-	-	
	Prismatic, Blocky, Granular	Weak	0.6	2.4	2.7	3.0	2.7	3.0	3.3	3.0	3.5	4.0
		Moderate, Strong	0.8	2.7	3.0	3.3	3.0	3.5	4.0	3.3	3.8	4.3
Sandy Clay Loam, Clay Loam, Silty Clay Loam	Massive	Structureless	-	-	-	-	-	-	-	-	-	-
	Platy	Weak, Moderate	-	-	-	-	-	-	-	-	-	
	Prismatic, Blocky, Granular	Weak	0.3	2.0	2.5	3.0	2.2	2.7	3.2	2.4	2.9	3.4
		Moderate, Strong	0.6	2.4	2.9	3.4	2.7	3.0	3.3	3.0	3.5	4.0
Sandy Clay, Clay, Silty Clay	Massive	Structureless	-	-	-	-	-	-	-	-	-	-
	Platy	Weak, Moderate	-	-	-	-	-	-	-	-	-	
	Prismatic, Blocky, Granular	Weak	-	-	-	-	-	-	-	-	-	
		Moderate, Strong	0.3	2.0	2.5	3.0	2.2	2.7	3.2	2.4	2.9	3.4

Advanced Enviro-Septic™ Sizing Table, continued

Table B - System Restrictions:

Infiltrative Loading Rate (ILR) gpd/sq.ft.	% System Slope Maximum	% Site Slope Maximum	Bed Configuration Limits
1.6 to 0.6	25	33	Any Configuration
0.5	15	20	
0.3 – 0.2	5	5	Basic Serial or Multiple Beds

Soil characteristics determined by Ohio Department of Health's "Site & Soil Evaluation for Sewage Treatment Dispersal" form, revised Sept. 2007

Table C - Minimum Pipe Requirements:

Loading (# Bedrooms)	Gallons per Day (300 gpd minimum)	Advanced Enviro-Septic™ Minimum Pipe Required (ft)
2	300	140
3	360	210
4	480	280
5	600	350
6	720	420
7	840	490
8	960	560
9	1,080	630
10	1,200	700

Note: Based on 120 gallons/day/bedroom

Section D System Configurations

Introduction

This section presents the various design configurations of the Advanced Enviro-Septic™ system. The system configuration to be used is limited by:

- Characteristics of the receiving soils
 - Vertical distance to the SHWT
 - Slope of the site
 - Other characteristics specific to the particular site
 - The design daily flow
-

System Configurations

The following Advanced Enviro-Septic™ system configurations are presented in this Section:

- Basic Serial
 - Combination Serial
 - Multiple Bed & Unique Site Solutions
 - In-Ground Systems
 - Elevated Systems
 - Non-Conventional
-

Basic Serial Distribution

Introduction

Basic Serial distribution can be used for single beds receiving 600 gallons per day (GPD) or less and for multiple beds where each bed receives 600 GPD or less. Basic Serial distribution systems are quick to develop a strong biomat in the first row and provide a longer flow route, providing improved effluent treatment. Basic Serial Distribution configuration also provides more complete air flow throughout all of the system's rows. Because these systems do not require a distribution box, they are less expensive, easier to construct and are not subject to the complications that can arise when a D-Box becomes out of level. Basic Serial distribution may be used in all soil types.

Definition

Basic Serial distribution incorporates rows in serial distribution in a single bed.

Centered Bed Configuration (for system slopes 5% or less) (inspection port not shown)

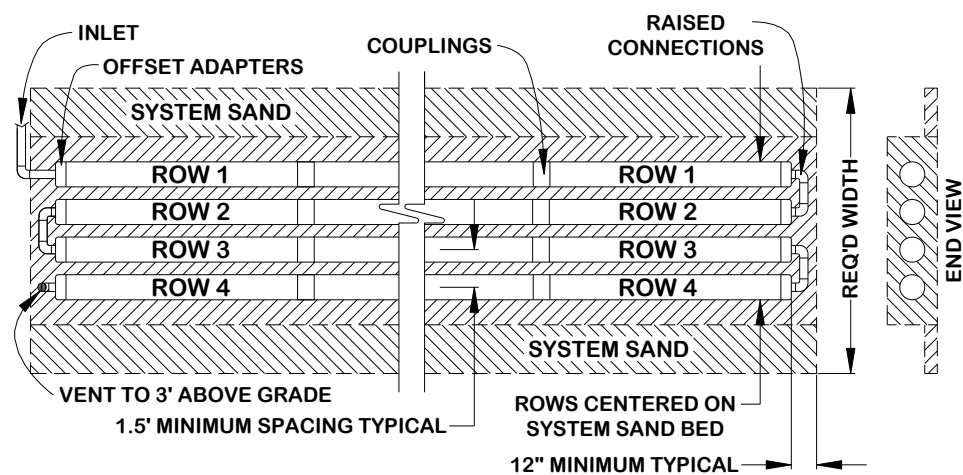

Rows grouped at high end of bed (for system slope over 5%) (inspection port not shown).

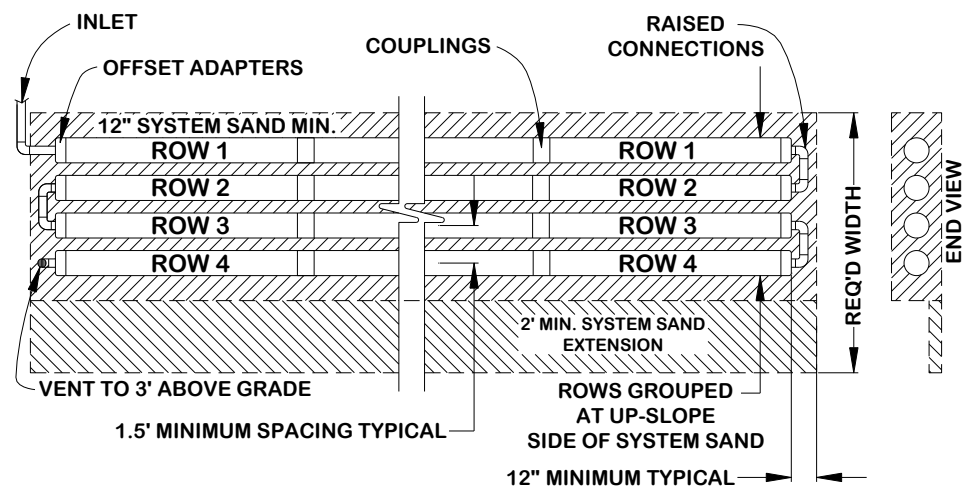

Basic Serial Distribution, continued

Butterfly Configuration

A butterfly configuration is considered to be a single bed with multiple serial sections. Each serial section must contain a minimum of half the required pipe. A section may contain more than the required amount of pipe. If vertical separation between serial sections exceeds 12 in., a multiple bed configuration must be used.

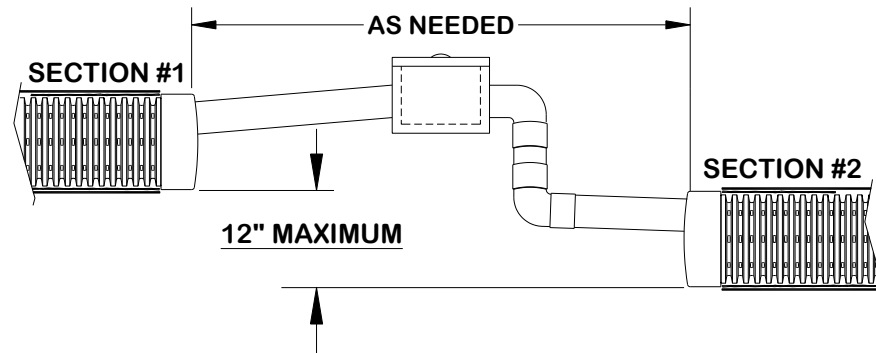

Butterfly Basic Serial Distribution (inspection port not shown)

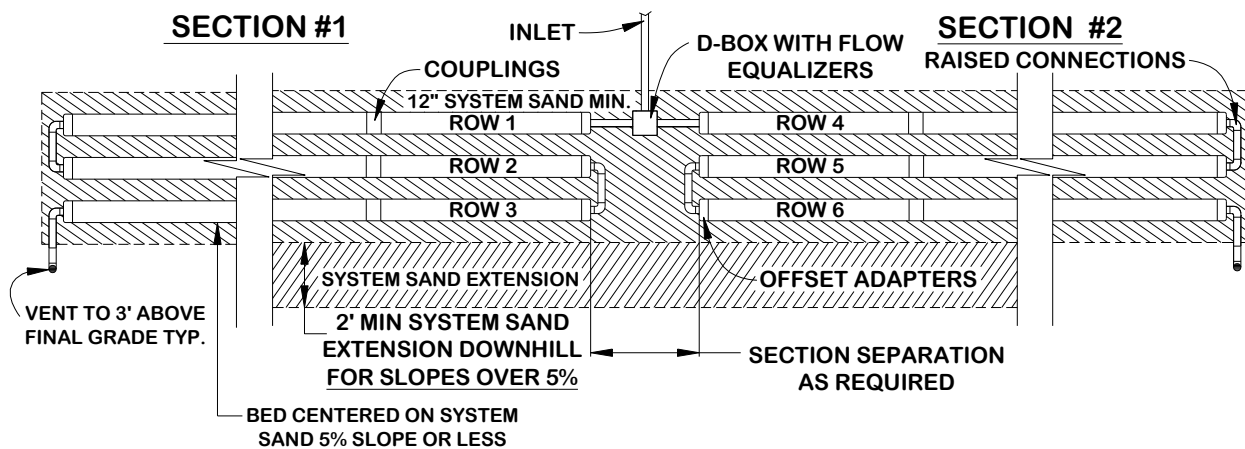

Combination Serial Distribution

Introduction	Combination Serial distribution is required for systems with design flows greater than 600 GPD in a single bed. Combination Serial distribution is quick to develop a strong biomat in the first row of each section, providing improved effluent treatment.
Limitations on Use	Use of Combination Serial distribution is permitted in all standard bed configurations in soils with an ILR between 1.6 and 0.5 as designated in Section C, Table B, System Restrictions, p. 9.
Definition	<u>Combination Serial distribution</u> incorporates two or more sections in a single bed, each section receiving an equal amount of effluent from a distribution box.
Flow Equalizers Required	All distribution boxes used to divide effluent flow require flow equalizers in their outlets. Flow equalizers are limited to a maximum of 20 gallons per minute (GPM).
Section Loading	Each section in a Combination Serial system has a maximum daily design flow of 600 GPD. More than the minimum number of Sections may be used.
Section Length Requirement	<ul style="list-style-type: none"> • Each section must have the same minimum linear feet of pipe. • The minimum linear feet of pipe per section is determined by dividing the total linear feet required in the Advanced Enviro-Septic™ system by the number of sections required. • A section may exceed the minimum linear length.

Combination Serial Distribution Plan View The following is a plan view of two sections in a single bed, each section receiving effluent from a distribution box (inspection port not shown).

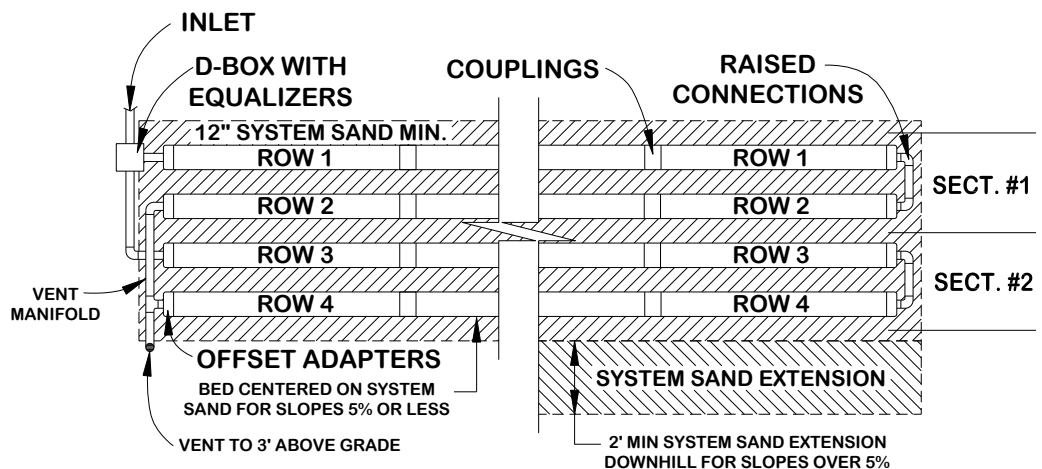

Combination Serial Distribution, continued

Butterfly Combination Serial Distribution (inspection port not shown)

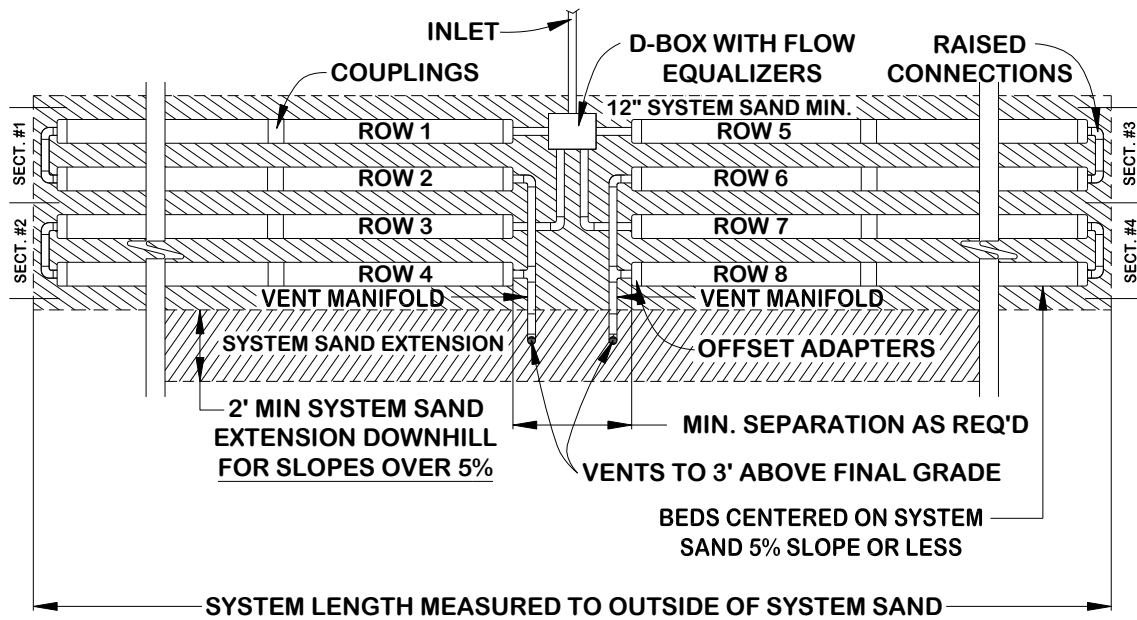

Distribution Box Configuration

D-Box Distribution Configuration (a.k.a. "Parallel" or "Finger" configuration)

All rows in this configuration must be the same length. Flow equalizers must be used in the D-Box. Manifold the ends of all rows to ensure adequate air and liquid flow through each row. Place the D-Box on level, firmly compacted soil. All rows must be laid level. A minimum of a 2 in. drop is required between the D-Box outlet and the Advanced Enviro-Septic™ pipe inlets.

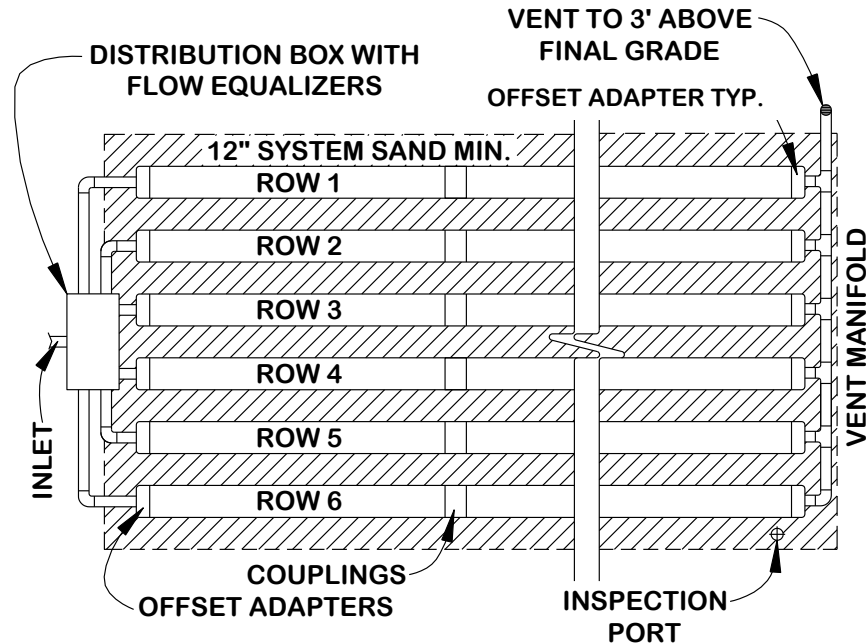

D-Box configuration for sloping beds:

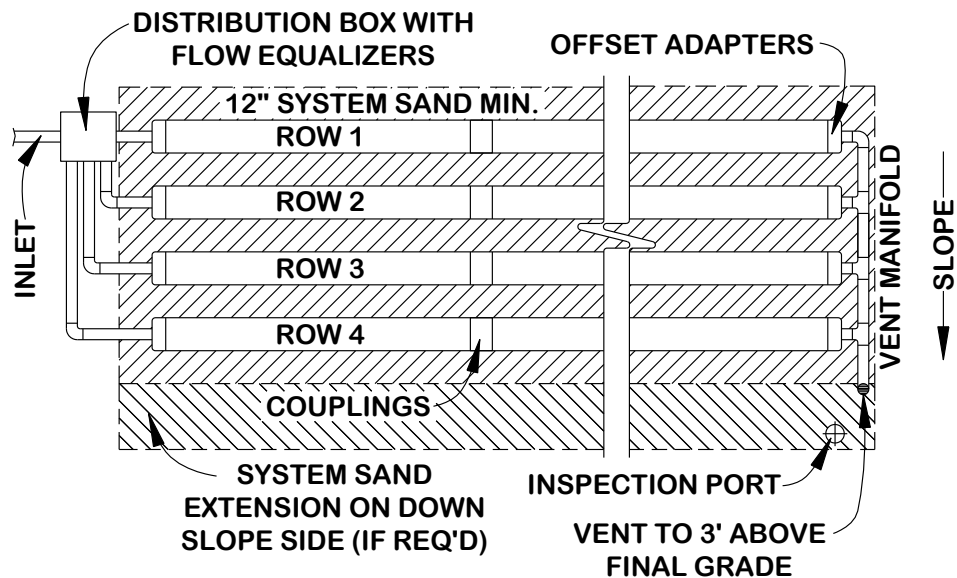

Multiple Bed Distribution and Unique Site Solutions

Introduction	Multiple Bed distribution and Unique Site Solutions may be used to accommodate site constraints.
Definition	Multiple Bed distribution incorporates two or more beds, each bed with Basic Serial or Combination Serial distribution, and each receiving an equal amount of effluent from a distribution box.
Flow Equalizers Required	All distribution boxes used to divide effluent flow require flow equalizers in their outlets. Flow equalizers are limited to a maximum of 20 GPM per equalizer.
Bed Length Requirement	<ul style="list-style-type: none">• Each bed must have the same minimum linear feet of pipe• The minimum linear feet of pipe per bed is determined by dividing the total linear feet required in the Advanced Enviro-Septic™ system by the number of beds.• A bed may exceed the minimum linear length.• Rows within a bed may vary in length to accommodate site constraints.
Bed Separation Distances	<p>Minimum bed separation distances:</p> <ul style="list-style-type: none">• No separation is required for butterfly configurations if beds are at the same elevation or within 1ft. of the same elevation• 10 ft. separation for end-to-end system multiple beds (measured pipe to pipe) <p><u>Note:</u> To accommodate construction access, additional separation distance may be necessary.</p>
Multiple Bed Orientation	Multiple beds may be oriented along the contour of the site or along the slope of the site. End-to-end configurations are preferred; however, side-to-side configurations are acceptable IF allowed for remedial use with state/local approval.

Multiple Bed Distribution & Unique Site Solutions, Continued

Multiple Bed Distribution Diagrams

The following are plan views of Multiple Bed distribution designs oriented along the contour of the site.

This Multiple Bed Basic Serial distribution configuration may be used in all soil types (inspection port not shown).

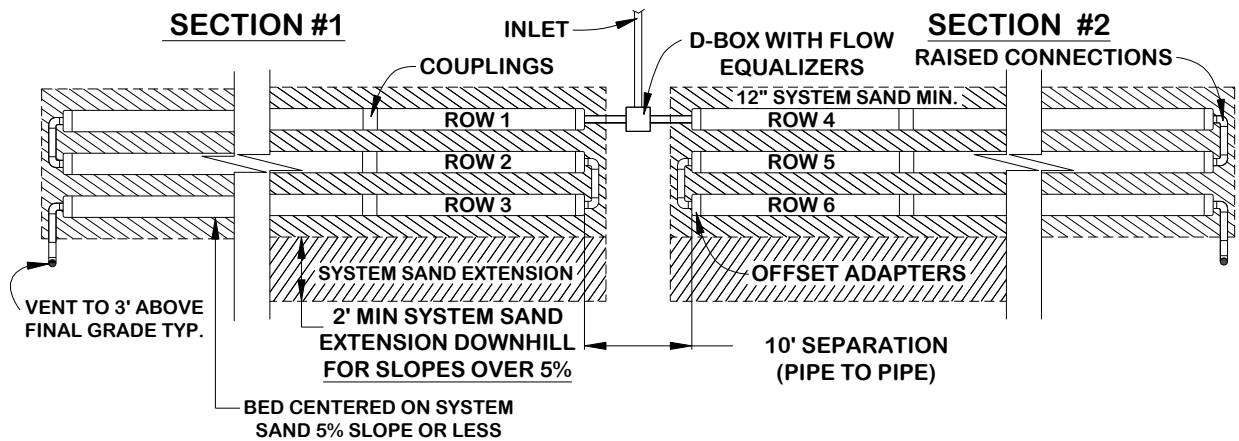

Multiple Bed Combination distribution (inspection port not shown):

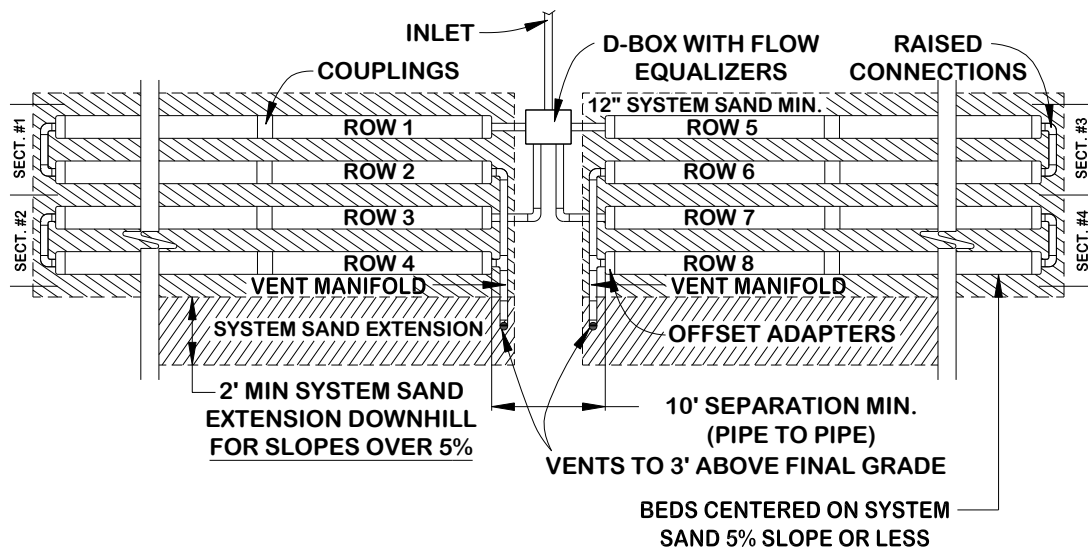

Multiple Bed Distribution & Unique Site Solutions, Continued

Angles

The AES System provides virtually unlimited flexibility allowing it to adapt to site constraints. When designing for a challenging site, feel free to contact us and a Technical Advisor will assist you in selecting an appropriate configuration. Angled configurations generally have one or more specific bends, but the rows should follow the contour of the site. Rows are angled by bending pipes or through the use of offset adapters. Length loading rates must still be honored. (Inspection Ports not shown.)

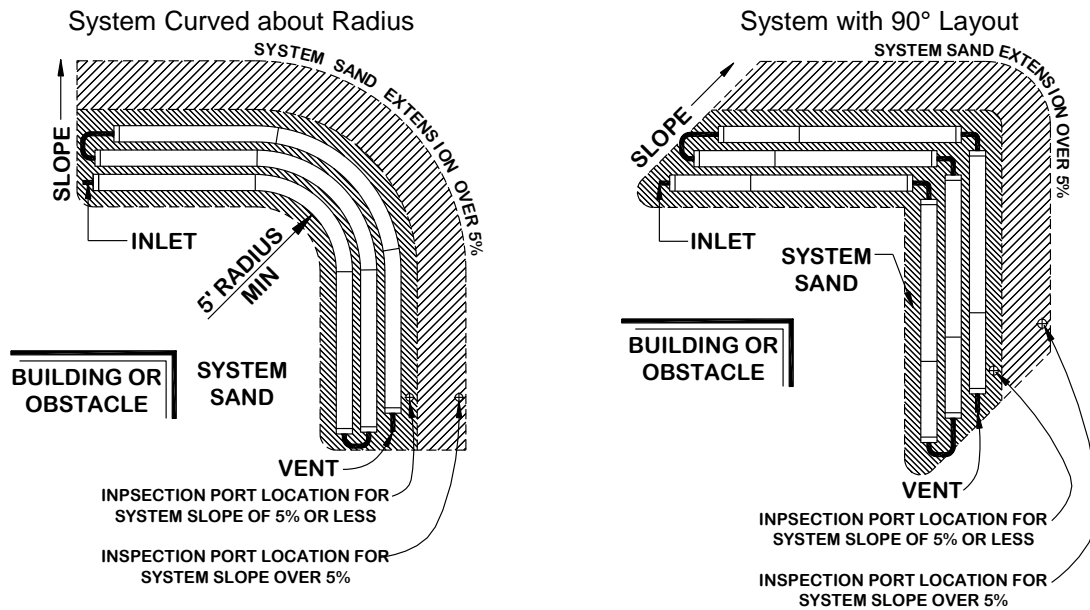

Note: A 10 ft. length of Advanced Enviro-Septic™ pipe may be bent up to 90°.

Curves

Curved configurations work well around structures, setbacks, and slopes. Multiple curves can be used if dictated by the contour of the site. (Inspection port not shown.)

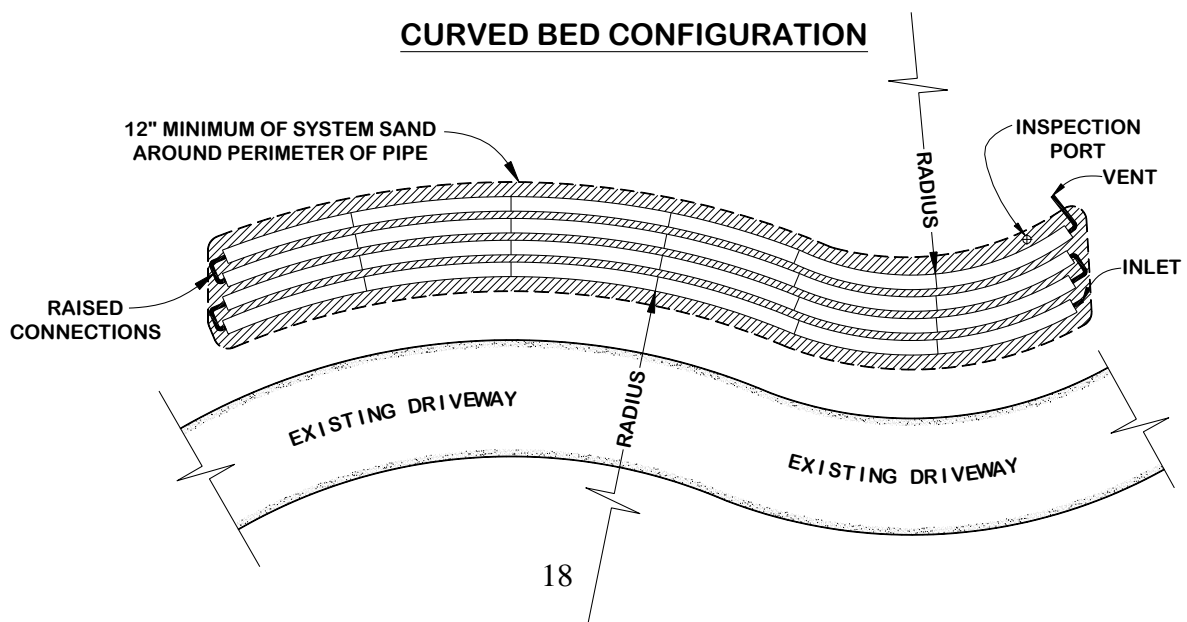

In-Ground Bed Systems Sloping 5% or Less

Introduction Advanced Enviro-Septic™ systems are installed below existing grade for sites with no soil restrictive features to limit placement.

Sloping Systems, Orientation of the Rows on the System Sand Bed In a system sloping 5% or less, the Advanced Enviro-Septic™ rows are centered on the System Sand bed.
 In a system sloping greater than 5%, the Advanced Enviro-Septic™ rows are positioned with 1ft. of System Sand on the upslope side and the remaining System Sand extends beyond the rows on the down slope side. In systems sloping greater than 5%, there must be a minimum of 3ft. of System Sand from the outermost edge of the pipe to the edge of the System Sand bed on the down slope side.

System Slope of 0% to 5% The following is a section view of an In-Ground bed system sloping 5% or less. Systems may slope up to 5% in all soil types (Infiltrative Loading Rates from 0.2 to 1.6). Refer to Advanced Enviro-Septic™ System Sizing Table, Section C, pp. 8-9, for system and site slope limitations, which are determined by the soil's ILR.

Pipes are centered on System Sand for systems sloping 5% or less.

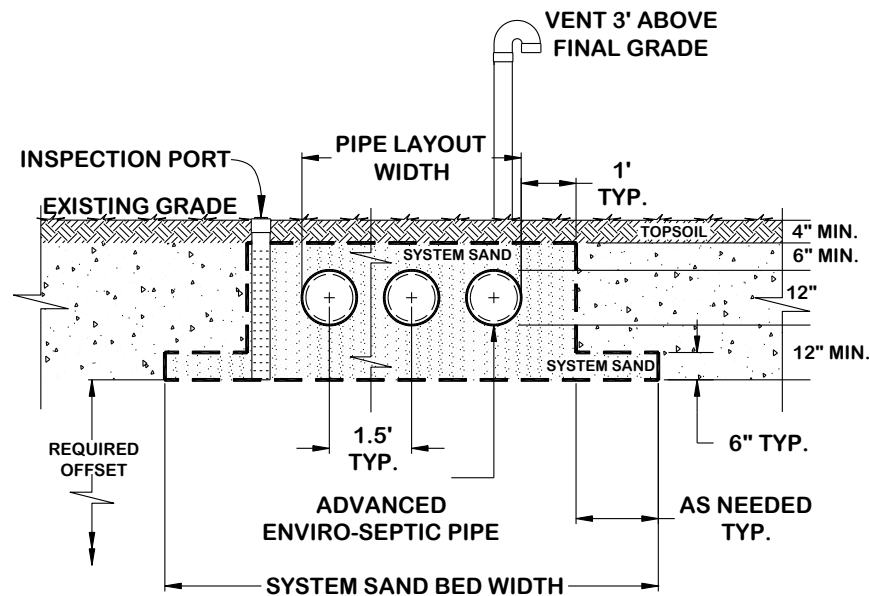

Note: System Sand extensions may not always be required depending on the soil's ILR and the required System Sand bed area required based on Table A.

In-Ground Bed Systems Sloping 5% or Less, Continued

System Sloping 5% or less:

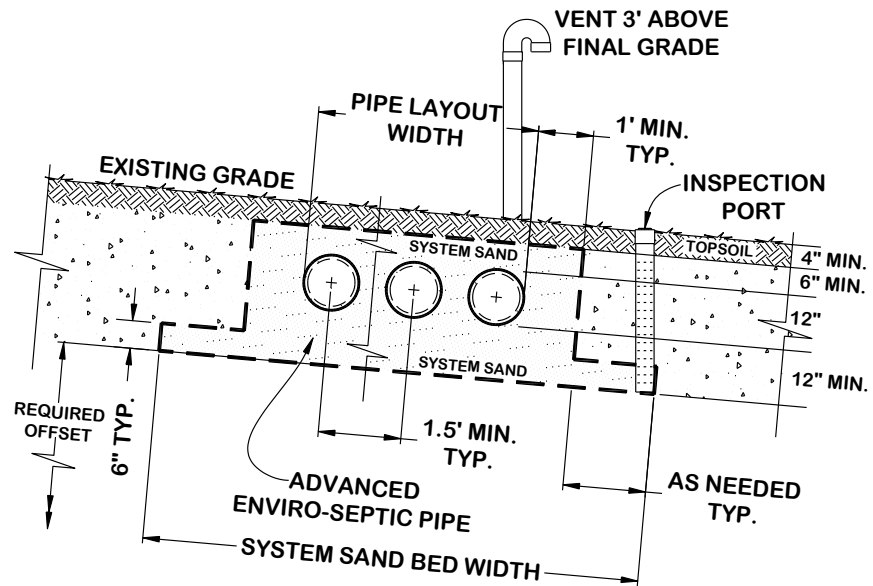

Note: Inspection Port always located at lowest edge of field

In-Ground Bed Systems Sloping Over 5% up to 25%

System Slope
Over 5% up to
25%

The maximum site and system slopes are determined based on the soil's Infiltrative Loading Rate (ILR). Refer to the Advanced Enviro-Septic™ System Sizing, Section C, pp. 8-9.

Systems Sloping over 5% - pipes are grouped to upslope side:

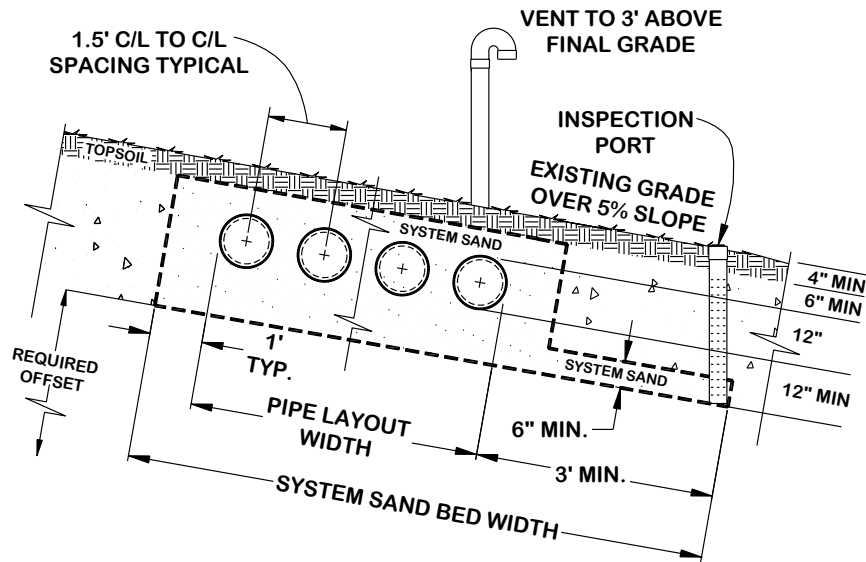

Elevated Bed Systems, Level and Sloping

Introduction Elevated Advanced Enviro-Septic™ systems are designed for sites with soil, depth to ground water or restrictive feature constraints that do not allow for In-Ground configurations.

Definition An Elevated bed system is a soil absorption field with any part of the system (including soil cover) above existing grade.

Elevated Systems Fill Extensions Side-slope tapering is to be 3 horizontal feet for each 1 foot of vertical drop.

Above ground system less than 5% slope and no System Sand extensions:
(Inspection port not shown.)

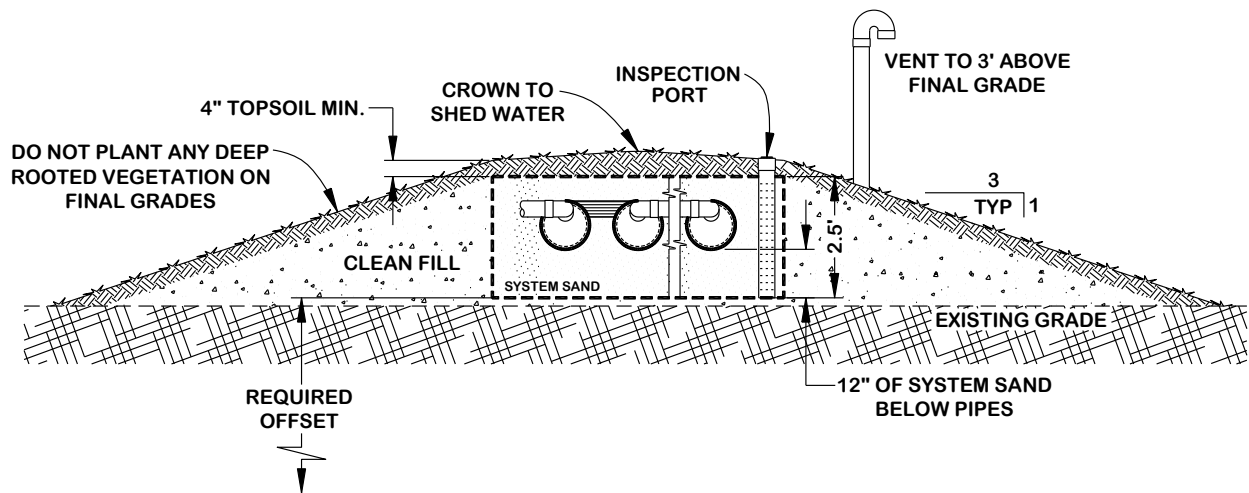

Elevated Bed Systems, Level and Sloping, continued

Centered pipe configuration with System Sand extensions:

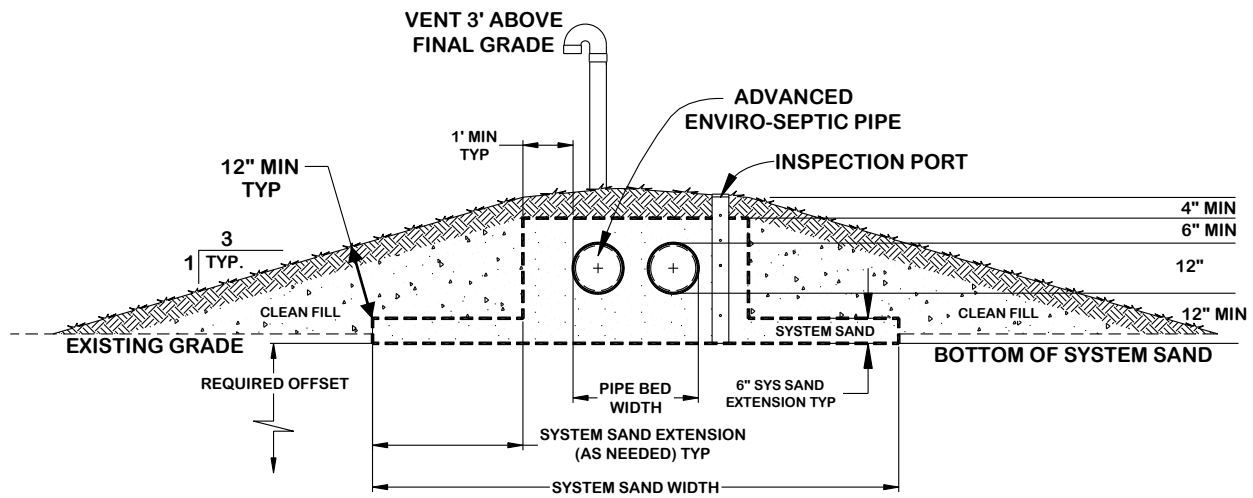

Sloping 5% or less with System Sand extensions and rows centered in System Sand:

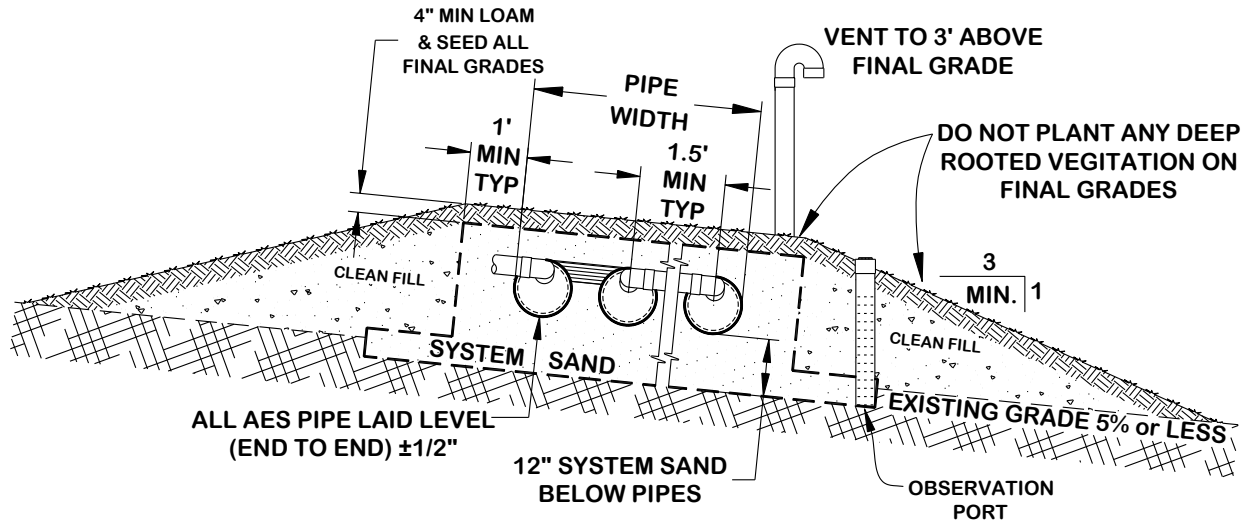

Orientation of the Pipes on the System Sand Bed, Level or $\leq 5\%$ Slope

System Slope and Site Slope

The percentage of slope in all illustrations refers to the slope of the Advanced Enviro-Septic™ system, not the existing terrain. The slope of the Advanced Enviro-Septic™ system and the existing terrain are not required to be equal. Refer to Table A, Loading Rates, Section C, p. 8 for maximum system and site slopes for various soil types.

Systems Sloping 5% or less

In a system sloping 5% or less, the Advanced Enviro-Septic™ rows are centered on the System Sand bed as shown in the Plan and Section Views below.

Rows centered on System Sand bed:

(Inspection port not shown.)

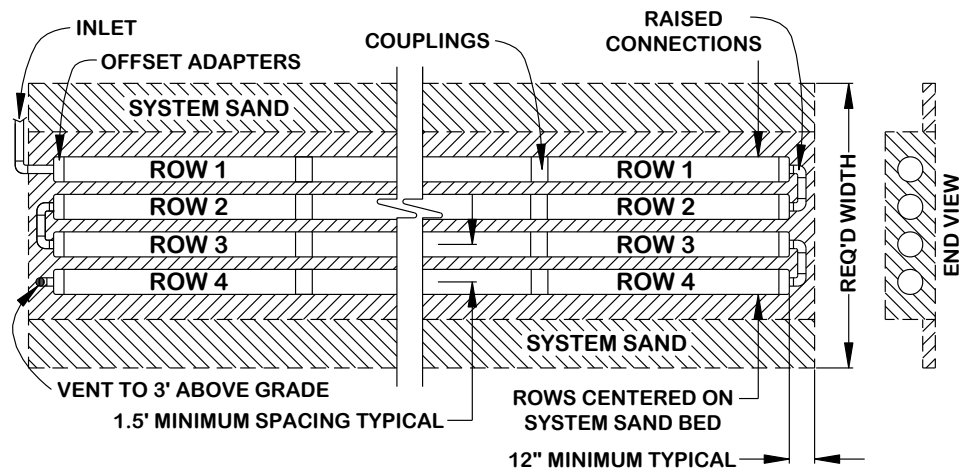

Orientation of the Pipes on the System Sand Bed, System Slope > 5%

Systems Sloping more than 5%

In a system sloping greater than 5%, the Advanced Enviro-Septic™ rows are positioned with 1 ft. of System Sand on the up-slope side with the remaining System Sand extending beyond the pipe on the down-slope side. In systems sloping greater than 5%, there must be a minimum of 3 ft. of System Sand beyond the last down-slope row of pipe. Any part of the System Sand bed that is more than 1 ft. away from the Advanced Enviro-Septic™ pipe needs to be only 6 in. deep, as shown in the Plan and Section views below.

Grouped bed configuration (in plan view) for System Slopes greater than 5%:

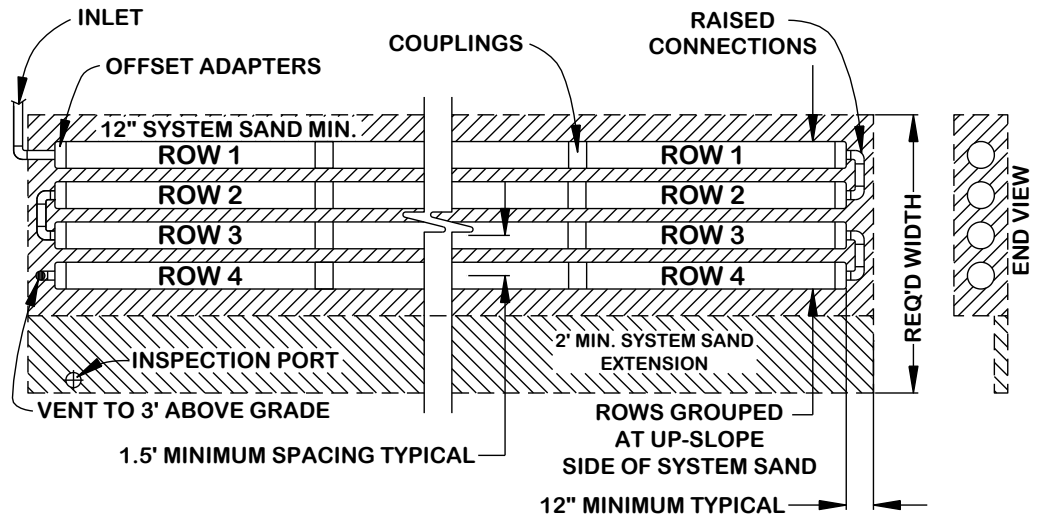

Section view of grouped bed configuration for System Slopes greater than 5%

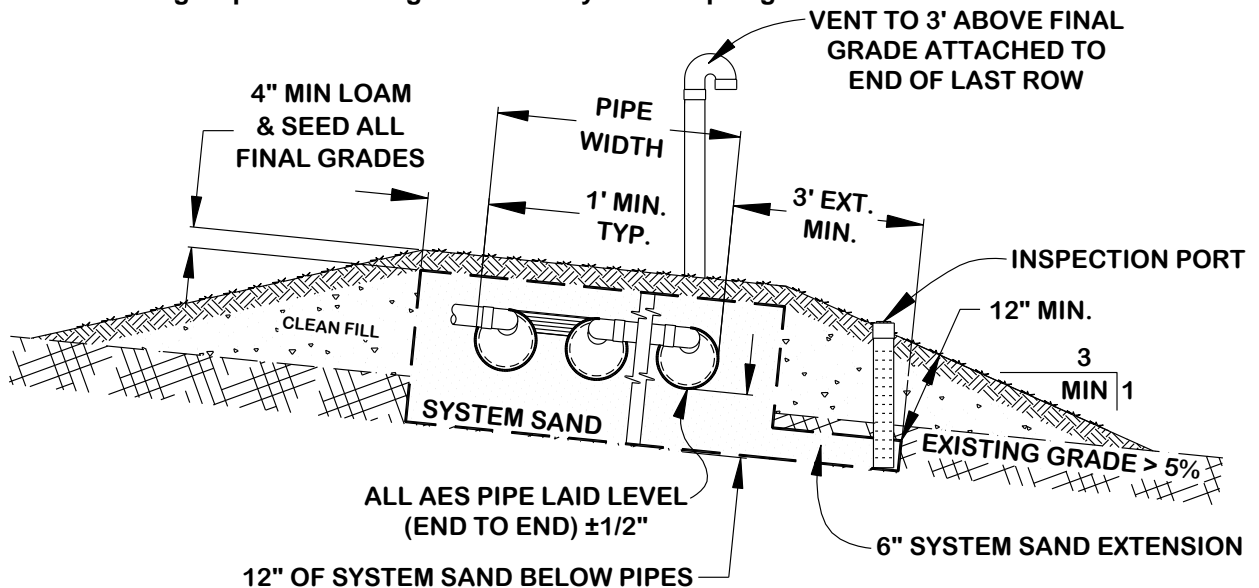

Section E General Design Criteria

Center-to-Center Spacing of Rows

Center-to-center spacing of Advanced Enviro-Septic™ rows is a minimum of 1.5 ft. for Advanced Enviro-Septic™ systems. Center-to-center spacing is measured from the center of one pipe to the center of the pipe in the next row. Center-to-center spacing of 1.5 ft. results in the minimum of 6 in. of System Sand between each row of Advanced Enviro-Septic™ pipe.

Daily Design Flow Calculations

Daily Design Flow is calculated based on 120 GPD per bedroom for residential systems. For each bedroom, a minimum of 70 ft. of Advanced Enviro-Septic® pipe is required. The minimum daily design flow for any system is 300 gallons per day.

D-Box Manifold

- A D-Box manifold is utilized to equalize flow.
 - Flow equalizers should be used on all D-Box outlets.
 - Unused D-Box outlets must be covered, plugged or mortared.
 - This configuration is especially useful when designing for large daily design flows. See "Velocity Reduction," this Section, p. 31.
-

Distribution box manifold is used to divide flow evenly to separate beds or sections:

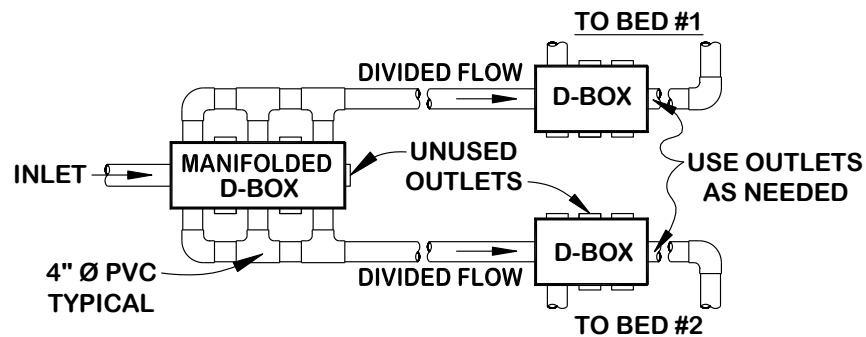

Note: Utilizing every other outlet will provide room for required piping and allow for easier installation. Install flow equalizers on all used outlets.

General Design Criteria, Continued

Baffles Required; Filters not Recommended	<ul style="list-style-type: none">• All septic tanks must be equipped with baffles to reduce the amount of solids exiting the tank and entering the Advanced Enviro-Septic™ system.• Effluent filters are not recommended by Presby Environmental, Inc. due to their tendency to clog if not properly maintained,, which restricts the oxygen supply that is essential to the functioning of the Advanced Enviro-Septic™ system.• If you are required to use an effluent filter in a gravity fed system due to state or local requirements, the effluent filter selected must allow the free passage of air to ensure the proper functioning of the system.
Garbage Disposals	<ul style="list-style-type: none">• If a garbage disposal is utilized, we recommend that the required liquid capacity of the septic tank be increased by 50%.• Multiple compartment septic tanks or multiple tanks are preferred.• If a garbage disposal is used, the septic tank will likely require more frequent pumping (see Section P, Operation & Maintenance, p. 57).
Isolation Distances	Minimum “isolation distances” or “setbacks” must comply with Ohio state and/or local requirements. Horizontal separation distances are measured from the outermost edge of the tall portion of the System Sand bed (not measured from System Sand Extension).
Row Elevations	For sloping sites, elevations must be provided on the construction drawing for each Advanced Enviro-Septic™ row in the system. This is referred to as an “elevation table.”
Row Orientation	Advanced Enviro-Septic™ rows must be laid level to within +/- 1/2 in. end-to-end and preferably will be approximately parallel to the contour of the site.
Minimum Number of Rows	All beds must have at least 2 parallel rows.
Maximum and Minimum Row Lengths	To maintain efficient effluent cycling within the Advanced Enviro-Septic™ pipe, the maximum row length is 100 ft. and the minimum row length is 30 ft. When design calculations result in a line length greater than 100 ft., multiple beds are required.

General Design Criteria, Continued

Orientation of Pipes on System Sand Bed

For Advanced Enviro-Septic™ systems sloping less than or equal to 5%, the System Sand extends horizontally a minimum of 12 in. beyond the outer perimeter of the Advanced Enviro-Septic™ pipes, with the pipes centered on the System Sand bed. (See illustration on p. 24).

For systems sloping from over 5% up to 25%, the Advanced Enviro-Septic™ rows are positioned (grouped) 1 ft. from the up-slope edge of the System Sand bed. A minimum of 3 ft. of System Sand is required beyond the last down-slope row. Any part of the System Sand bed more than 1 ft. away from the Advanced Enviro-Septic™ pipe only needs to be 6 in. deep. (See illustration on p. 25).

Pipe Length Required

Total minimum length of Advanced Enviro-Septic™ pipe required for a residential system is 70 ft. of pipe per bedroom. (Note: minimum system size is two (2) bedrooms.)

Pumped System Requirements

- Pumped systems to gain elevation are allowed with the Advanced Enviro-Septic™ system.
- The use of pressure distribution with the Advanced Enviro-Septic™ system is **not** permitted.
- Systems incorporating pumps to gain elevation must use differential venting and velocity reduction to control liquid flow. (Refer to Section J, Venting Requirements, pp. 42-46.)
- Pump dose volume is limited to a maximum of 40 GPM for Basic Serial Systems.
- When flow is divided by a D-Box, equalizers are required and dose volume is limited to a maximum of 20 GPM per flow equalizer.

Reference: See Section H, Pumped System Requirements, p. 39.

General Design Criteria, Continued

Replacement Systems

In the unlikely event that an Advanced Enviro-Septic™ system needs to be replaced...

- It can be reinstalled in the same location.
 - All unsuitable material must be removed and properly disposed of prior to replacement system construction and replaced with clean System Sand.
 - Dispose of hazardous materials properly.
 - Permits are required for system replacement; contact the appropriate approving authority.
 - Attempt Rejuvenation procedures before replacing the system. This simple process can often restore normal system function in a matter of days. Refer to Section Q, Rejuvenation and Expansion, p. 58-59 **and** call PEI for technical assistance.
 - Ohio State and Local regulations may require a reserve area for new systems.
-

Required Depth Vertical Separation Distances

- AES has been approved by ODH for a one 1 ft. soil depth credit for fecal coliform reduction.
 - The System Sand/soil interface 12 in. below the pipes is considered the “bottom” of the System bed and is where vertical separation distances are measured from.
 - There must be a minimum of 6 in. of unsaturated soil between the AES bed bottom and restrictive feature.
-

Septic Tank and D-Box Elevations

The outlet of a septic tank or D-Box must be set at least 2 in. above the highest inlet to the first Advanced Enviro-Septic™ row, with the connecting pipe slope not less than 1% (approximately 1/8 in. per foot.)

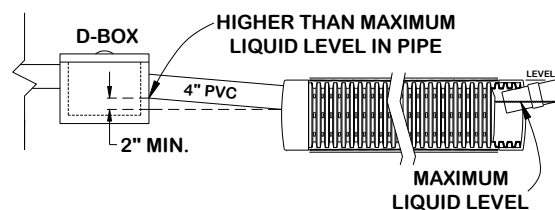

Side Slope Tapering

Side slope tapering is to be a minimum of 3:1.

General Design Criteria, Continued

Sloping Sites

- The percentage of slope in all system drawings refers to the slope of the Advanced Enviro-Septic™ system, not the existing terrain.
 - The system slope and the site slope do not have to be the same.
 - Maximum site slope is 33% and maximum system slope is 25%; permissible slope varies depending on the soil's ILR (see Section C, Loading Rate Table, p. 8.)
 - The site and/or the system may contain more than one slope, provided the maximum allowed slope is not exceeded.
 - If the system slopes more than 5%, the Advanced Enviro-Septic™ pipes will be placed 1 ft. from the up-slope edge of the System Sand bed. The System Sand bed will extend a minimum of 3 ft. past the last row on the down-slope side.
 - Remember any portion of the System Sand bed that is more than 1 ft. away from the Advanced Enviro-Septic™ pipes only needs to be 6 in. deep.
 - The width of the System Sand bed will sometimes need to be increased in order to achieve the minimum required 3 ft. past the most down-slope row of pipe.
-

System Sand Bed Vertical Dimensions

The overall height of an Advanced Enviro-Septic™ system measures 30 in. (including System Sand, not including fill or cover materials):

- 12 in. of System Sand below the Advanced Enviro-Septic™ pipe;
 - 12 in. diameter of the Advanced Enviro-Septic™ pipe; and
 - 6 in. of System Sand above the Advanced Enviro-Septic™ pipe.
 - The System Sand Extension is any portion of the System Sand bed that is more than 1 ft. from the outermost perimeter of any Advanced Enviro-Septic™ pipe); this portion of the System Sand bed only needs to be a minimum of 6 in. deep.
-

System Sand Specifications

It is **critical** to the proper functioning of the Advanced Enviro-Septic™ system that the proper amount and type of System Sand be installed. Refer to Section L, System Sand and Fill Material Specifications, p. 48.

Ten Foot Increments Work Best

It is easier if row lengths are designed in exact 10 ft. increments since Advanced Enviro-Septic™ pipe comes in 10 ft. sections. However, if necessary, the pipe is easily cut to **any** length to meet site constraints. Using 5 ft. increments minimizes waste of pipe material.

Topographic Position Requirement

The topographic position of the site must be convex, hill slope, or flat. No onsite system may be located on concave terrain that concentrates surface or ground water flows unless the up-slope terrain is sufficiently altered to redirect water away from the system. Refer to Section K, Site Selection, p. 47 for additional information and tips about selecting the right location for an Advanced Enviro-Septic™ System. Also refer to Section O, Final Grading, pp. 55-56.

General Design Criteria, Continued

Velocity Reduction

- Velocity reducers are recommended between the septic tank and the Advanced Enviro-Septic™ System.
- A velocity reducer prevents turbulence which can disrupt the natural settling of solids within the Advanced Enviro-Septic™ pipes.
- D-Boxes with baffles or a velocity reducing tee are commonly used for velocity reduction. See drawing below.
- Velocity reducers are required in pumped systems.

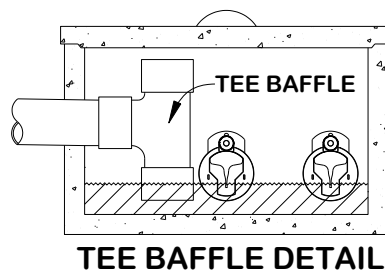

Venting Requirements

All Advanced Enviro-Septic™ Systems require venting. Pumped systems require differential venting. Refer to Section J, Venting Requirements, pp. 42-46.

Wastewater Strength

- All design criteria in this Manual assume “usual” or “typical” residential wastewater strength. Designers should take any unusual wastewater characteristics into consideration in designing a system.
 - Where wastewater strength is high or wastes are unusual, additional Advanced Enviro-Septic™ pipe is recommended. Please contact us for technical assistance.
-

Water Purification Systems

- Water purification systems and water softeners are **not permitted** to discharge into an Advanced Enviro-Septic™ system.
 - This “backwash” does not require treatment and the additional flow may overload the system. Designs should include an alternative means of dispersal.
-

Section F Ohio State Specific Information

Certification Requirements

Designers or Installers are required to be trained and certified by Presby Environmental, Inc. or its sanctioned representative. Homeowners are permitted to design and install their own Advanced Enviro-Septic™ systems in Ohio and also must be trained and certified by Presby Environmental, Inc. Presby Environmental's certification does not require renewal. Regulators involved in the approval and inspection of Advanced Enviro-Septic™ systems should also attend PEI certification training.

Additional requirements and/or registrations by state and local authorities may be required.

Design Flow

- Residential design flow for the Advanced Enviro-Septic™ system is calculated using the Ohio Department of Health's figure of 120 GPD per bedroom.
- The **minimum** daily design flow for any system is 300 GPD.
- The **maximum** daily design flow for a residential system is ten (10) bedrooms (1,200 GPD).
- Certain fixtures, such as jetted tubs, may require an increase in the size of the septic tank.

When daily design flow is determined by water meter use, take the average daily use from a peak month and multiply it by a peaking factor of 2 to 3 times.

Note: The Advanced Enviro-Septic™ system does **not** utilize pressure distribution in any system **regardless** of the design daily flow. Pumps are to be used with the Advanced Enviro-Septic™ system **only** to gain elevation.

Design Restriction

Systems in Ohio with a daily design flow greater than five bedrooms (greater than 600 GPD) are required to be designed as Combination or Multiple Bed configurations. A minimum of two Serial Sections are required when loading exceeds five bedrooms (600 GPD).

Inspection Port Required

An inspection port to enable monitoring is required. One capped inspection port of 4 in. PVC will be installed with access at final grade; the inspection port is located at the center edge of each System Sand Bed with the bottom of the port located at the System Sand / soil interface (downslope side if sloping system).

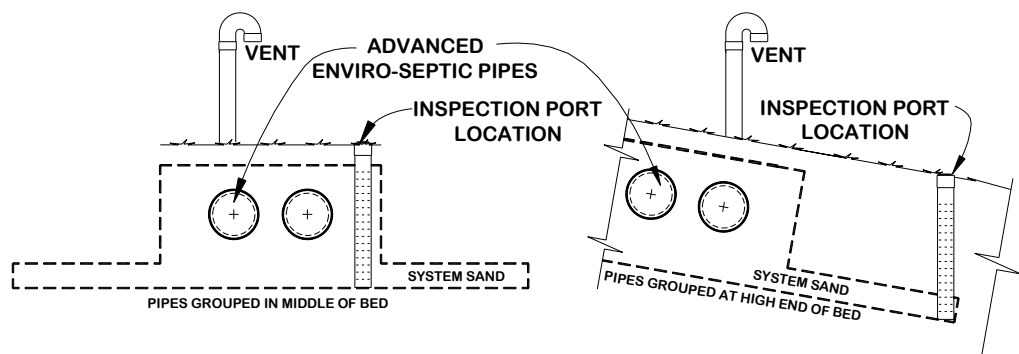

Ohio State Specific Information, continued

Loading Limits	Combination Serial Section loading limit is 600 GPD.
Pressure Distribution	The use of pressure distribution in Advanced Enviro-Septic™ wastewater treatment systems is prohibited .
Setbacks (Isolation Distances)	Horizontal setbacks (“isolation distances”) are measured from the outer perimeter of the tall portion of the System Sand Bed.
Site Restrictions	Systems may not be placed beneath roadways, driveways, parking lots, or other hard surface areas.
Venting Requirements	<p>All Advanced Enviro-Septic™ systems are required to be vented. Pumped systems require differential venting.</p> <p>See Section J, “Venting Requirements,” pp. 42-46.</p>
Required Depth Vertical Separation Distances	<ul style="list-style-type: none">• AES has been approved by ODH for a one 1 ft. soil depth credit for fecal coliform reduction.• The System Sand/soil interface 12 in. below the pipes is considered the “bottom” of the System bed and is where vertical separation distances are measured from.• There must be a minimum of 6 in. of unsaturated soil between the AES bed bottom and restrictive feature.

Section G

Design/Sizing Procedures & Examples

Distribution Configurations

Effluent may be distributed in Elevated or In-Ground systems using:

- Serial distribution
 - Combination Serial distribution
 - Multiple Bed distribution
 - Distribution Box (“finger” or “parallel”) distribution
-

Design Notes

- AES has been approved by ODH for a 1 ft. soil depth credit for fecal coliform reduction.
 - Minimum separation distance from bed bottom to restrictive feature is 6 in. of unsaturated soil.
 - Maximum row length is 100 ft. and minimum row length is determined by the Length Loading Rate (LLR).
 - When row length calculations exceed 100 ft., multiple beds are required to satisfy linear loading rates.
 - Ten foot increments work best and minimize waste.
 - Minimum center-to-center spacing from the center of one row to the center of the next is 1.5 ft. (18 in.)
 - Each bed in a multiple bed system must be equal in length.
 - Site slope maximum is 33%; system slope maximum is 25%. Allowable slope varies according to the soil’s Infiltrative Loading Rate (ILR) from Advanced Enviro-Septic™ System Sizing, Section C, p. 8-9.
 - Advanced Enviro-Septic™ rows must be laid level end-to-end to within 1/2in. and preferably should be parallel to the contour of the site.
 - System should not be located where surface waters concentrate.
 - Isolation distances are measured from the outermost edge of the tall portion of the System Sand bed.
 - System Sand bed lengths and widths are always a minimum of 2 ft. longer than row lengths and pipe layout width due to the required 1ft. minimum of System Sand on all four sides of the Advanced Enviro-Septic™ pipes.
 - All sections within a bed must be equal in length and one foot from the end of the System Sand bed.
 - Each bed must contain a minimum of two rows.
 - All systems must be vented. Refer to Section J, Venting Requirements, pp. 42-46.
 - All systems require proper soil cover and grading (Refer to Section O, Final Grading, pp. 55-56).
-

Loading Limit Specifications

- Each Advanced Enviro-Septic™ system bed with Basic Serial distribution may receive no more than five bedrooms (600 GPD) design loading.
- Each section with Combination Serial distribution may receive no more than five bedrooms (600 GPD) design loading.
- The minimum size for any system is 300 GPD.
- The maximum design daily flow for a residential Advanced Enviro-Septic™ system in Ohio is ten (10) bedrooms (1,200 GPD).
- Advanced Enviro-Septic™ loading limit is 2.38 gallons / linear foot / day maximum.

Bed Sizing Procedure & Worksheet

<p>1. <u>Effluent Loading</u> Determine the system's daily effluent loading in total number of bedrooms x 120 GPD (2 bdrm = 300 gpd min.)</p>	<p>1. Loading in GPD (300 gpd min.)</p>	
<p>2. <u>Infiltrative Loading Rate (ILR)</u> From Section C Sizing Table A Select infiltrative loading rate (ILR) Gal/day/ft² for appropriate soil condition</p>	<p>2. Select ILR Gal/day/ft² Table A</p>	
<p>3. <u>Linear Loading Rate (LLR)</u> From Section C Sizing Table A Select the linear loading rate (LLR) Gal/day/ft for the appropriate soil condition</p>	<p>3. LLR Gal/day/ft Table A</p>	
<p>4. <u>Minimum Total System Sand Bed Area</u> Divide GPD loading (step #1) by ILR (step #2) to determine the minimum system sand bed area required.</p>	<p>4. Min. System Sand bed area (GPD ÷ ILR)</p>	
<p>5. <u>Minimum Total System Sand Length</u> Divide GPD loading (step #1) by LLR (step #3) to determine the minimum bed length</p>	<p>5. Min. Total System Sand bed Length (GPD ÷ LLR)</p>	
<p>6. <u>Minimum Number of Beds Required</u> Divide min. total system sand length (step #5) by 102 (max. sand bed length) & round up if not whole number</p>	<p>6. Min. Number of Beds (min. sand length ÷ 102)</p>	
<p>7. <u>Advanced Enviro-Septic™ Pipe Req'd</u> Determine min. amount of Enviro-Septic® pipe required based on bedrooms from Table C</p>	<p>7. Feet of AES pipe req'd from Table C</p>	
<p>8. <u>Pipe Row Length per Bed</u> Divide Total System Sand Length (step #5) by number of beds (step #6) and subtract 2 ft. Pipe Row Length 100 ft. maximum</p>	<p>8. Row length 100 ft. max. per bed</p>	
<p>9. <u>Number of Rows per Bed</u> Total pipe req'd (step #7) ÷ number of beds (step #6) Then ÷ by Row length (step #8) rounded up to nearest whole number.</p>	<p>9. Number of rows (2 minimum)</p>	
<p>10. <u>Bed System Sand Width</u> Determine width if slope is 5% or less: [(Number of AES rows (step #9) - 1) x 1.5'] + 3' Determine width if slope is more than 5%: [(Number of E-S rows from (step #9) - 1) x 1.5'] + 5' Note: Never less than LLR (step #3) ÷ ILR (step #2)</p>	<p>10. System Sand Bed Width</p>	

Design/Sizing Procedures & Examples, continued

Bed Sizing Example #1

1. Number of bedrooms = (4) = 4 x 120 GPD = 480 GPD total loading
2. Infiltrative loading rate, Section C Sizing Table A (ILR) = 1.0 GPD/ft² (fine sand)
3. Linear Loading Rate (LLR) = 5.5 GPD/ft for Site Slope (not System Slope) of 4% and Infiltrative Distance >24"
4. Minimum dispersal area = 480 GPD ÷ 1.0 = 480 ft² minimum System Sand area
5. Minimum Total System Sand length = 480 GPD ÷ 5.5 GPD/ft = 87.3 ft min (round up to 88 ft.)
6. Minimum number of beds required = 88 ÷ 102 = 0.9 (round up to one bed x 88 ft. long)
7. Minimum Advanced Enviro-Septic™ pipe required for four bedrooms (480 GPD)
from Table C = 280 ft. minimum
8. Advanced Enviro-Septic™ pipe row length = (88 ft. ÷ 1 bed) – 2 ft. (1 ft. per side for System Sand)
Minimum row length = 86 ft.
9. Number of rows = 280 ft. of pipe ÷ 86 ft. row length = 3.26 rows (round up to 4 rows)
10. Bed System Sand width = LLR ÷ ILR = 5.5 ft.
= [(4 rows – 1) x 1.5 ft. spacing] + 3 ft. = 7.5 ft. sand bed width
7.5 ft. is greater than 5.5 ft., so 7.5 ft. must be used

Summary:

System Sand bed area required = 480 ft²
System Sand bed area provided = 660 sq.ft. total

Advanced Enviro-Septic™ pipe required = 280 ft.
Advanced Enviro-Septic™ pipe used = 4 rows x 86 ft. = 344 ft. total

Number of Advanced Enviro-Septic™ rows used = 4

Advanced Enviro-Septic™ pipe row length minimum = 86 ft.
Advanced Enviro-Septic™ pipe row length used = 86 ft.

Alternate bed configuration:

System Sand bed length = 97 ft.
Advanced Enviro-Septic™ pipe row length = 95 ft.
Number of rows = 3

System Sand bed width = 6 ft.
System Sand bed area = 582 sq.ft.

This configuration will use less pipe, but more sand. Both would be acceptable configurations.

Design/Sizing Procedures & Examples, continued

Bed Sizing Example #2

1. Number of bedrooms = (4) = 4 x 120 GPD = 480 GPD total loading
2. Infiltrative loading rate, Section C Sizing Table A (ILR) = 0.3 GPD/ft² (Sandy clay, granular, strong)
3. Linear Loading Rate (LLR) = 2.5 GPD/ft for Site Slope (not System Slope) of 4% and Infiltrative Distance 12" to 24"
4. Minimum dispersal area = 480 GPD ÷ 0.3 GPD/ft² = 1,600 ft² minimum System Sand area total
5. Minimum Total System Sand length = 480 GPD ÷ 2.5 GPD/ft = 192 ft minimum total length
6. Minimum number of beds = 192 ÷ 102 = 1.9 (round up to 2 beds x 96 ft. long)
7. Minimum Advanced Enviro-Septic™ pipe required for four bedrooms (480 GPD)
from Table C = 280 ft. minimum
8. Advanced Enviro-Septic™ pipe row length: maximum row length is 100 ft. requiring (2) beds minimum
 - minimum sand bed length = 192 ft. ÷ 2 beds = 96 ft.
 - minimum Row length = 96 ft. – 2 ft. (1 ft. per side for System Sand) = 94 ft.
9. Number of rows = 280 ft. of pipe ÷ 2 beds ÷ 94 ft. row length = 1.49 (round up to 2 rows per bed)
10. Minimum System Sand Bed width = LLR ÷ ILR = 8.4 ft. wide
Minimum Bed's System Sand width using Advanced Enviro-Septic™ pipe required:
= [(2 rows – 1) x 1.5 ft. spacing] + 3 ft. = 4.5 ft. sand bed width
4.5 ft. is less than 8.4 ft., so 8.4 ft. min. must be used

Summary:

System Sand bed area required = 1,600 ft² total

System Sand bed area provided = 1,613 sq.ft. total

Advanced Enviro-Septic™ pipe required = 280 ft. total

Advanced Enviro-Septic™ pipe used = 376 ft. total

Number of Advanced Enviro-Septic™ rows used = 2 per bed

Advanced Enviro-Septic™ pipe row length minimum = 94 ft. per bed

Advanced Enviro-Septic™ pipe row length used = 94 ft.

Minimum number of beds required = 2

Number of beds provided = 2 (butterfly system)

Design/Sizing Procedures & Examples, continued

Bed Sizing Example #3

1. Number of bedrooms = (5) = 5 x 120 GPD = 600 GPD total loading
2. Infiltrative loading rate, Section C Sizing Table A (ILR) = 0.3 GPD/ft² (Clay Loam, Granular, Weak)
3. Linear Loading Rate (LLR) = 2.7 GPD/ft for Site Slope (not System Slope) of 9% and Infiltrative Distance 12" to 24"
4. Minimum dispersal area = 600 GPD ÷ 0.3 GPD/ft² = 2,000 ft² minimum System Sand area
5. Minimum Total System Sand length = 600 GPD ÷ 2.7 GPD/ft = 222.3 ft. min. total length
6. Minimum number of beds = 222.2 ÷ 102 = 2.2 (round up to 3 beds x 75 ft. long)
7. Minimum Advanced Enviro-Septic™ pipe required for four bedrooms (600 GPD)
from Table C = 350 ft. minimum
8. Advanced Enviro-Septic™ pipe row length: maximum row length is 100 ft. requiring (3) beds minimum
- minimum sand bed length = 222.2 ft. ÷ 3 beds = 74.1 ft. rounded up to 75 ft.
- minimum Row length = 75 ft. – 2 ft. (1 ft. per side for System Sand) = 73 ft.
9. Number of rows = 350 ft. of pipe ÷ 3 beds ÷ 73 ft. row length = 1.6 rows (round up to 2 rows per bed)
10. Minimum System Sand Bed width = LLR ÷ ILR = 2.7 ÷ 0.3 = 9 ft. wide
Minimum Bed System Sand width using Advanced Enviro-Septic™ pipe required:
= [(2 rows – 1) x 1.5 ft. spacing] + (5 ft. = 3 ft. + 2 ft. extension) = 6.5 ft. sand bed width
6.5 ft. is less than 9 ft., so 9 ft. minimum must be used.

Summary:

System Sand bed area required = 2,000 ft²
System Sand bed area provided = 2,025 sq.ft. total
Advanced Enviro-Septic™ pipe required = 350 ft.
Advanced Enviro-Septic™ pipe used = 438 ft. total
Number of Advanced Enviro-Septic™ rows used = 2 per bed
Advanced Enviro-Septic™ pipe row length minimum = 72.1 ft.
Advanced Enviro-Septic™ pipe row length used = 73 ft.
Minimum number of beds required = 3
Number of beds provided = 3 (multiple bed configuration)

Alternate bed configuration:

System Sand bed length = 82 ft. x 3 beds
Advanced Enviro-Septic™ pipe row length = 80 ft.
Number of rows = 2
System Sand bed width = 9 ft.
System Sand bed area = 2,079 sq.ft.

This configuration will use more pipe, but will be narrower. Both would be acceptable configurations.

Section H Pumped System Requirements

Introduction	Pumped systems supply effluent to the Advanced Enviro-Septic™ system using a pump and D-Box when site conditions do not allow for a gravity system.
Differential Venting	<p>All pumped systems must use differential venting.</p> <p><u>Reference:</u> See Section J, Venting Requirements, pp. 42-46.</p>
D-Box	All pumped systems require a D-Box. See “Velocity Reduction,” below.
Velocity Control	The rate at which effluent enters Advanced Enviro-Septic™ pipe must be controlled. Excessive effluent velocity can disrupt solids that settle in the Advanced Enviro-Septic™ pipes.
Velocity Reduction	<ul style="list-style-type: none">• Effluent must never be pumped directly into Advanced Enviro-Septic™ pipe.• A D-Box or tank must be installed between the dose tank (sometimes called a “pump chamber”) and Advanced Enviro-Septic™ pipe to reduce effluent velocity.• Force mains must discharge into a D-Box with a velocity reducer such as a baffle, 90° bend, or tee. Refer to drawing on p. 31.
Dose Volume	<ul style="list-style-type: none">• Pump volume per dose must be no greater than 1 gallon times the total length of all rows.• Pump dosing must be a minimum of 4 times per day; 6-8 cycles per day are recommended.• The dosing cycle should provide at least one hour between doses.• Pump dose volume is limited to a maximum of 20 GPM per equalizer.
Basic Serial Distribution Limit	Systems with Basic Serial distribution are limited to a maximum dose rate of 40 gallons per minute with no equalizers.
Combination and Multiple-Bed Distribution Limit	All Advanced Enviro-Septic™ systems with Combination Serial distribution or Multiple Bed distribution must use flow equalizers in D-Box outlets. Since most flow equalizers are limited to a maximum of 20 GPM, each bed or Section of Combination Serial distribution is limited to a maximum of 20 GPM.

Section I Perimeter Drains

Perimeter Drains

- A perimeter drain (also called a “curtain drain”) is an in-ground drainage system that is used to capture subsurface waters from the soil around the proposed system area.
- Perimeter drains may be used with the Advanced Enviro-Septic™ system.
- Perimeter drains should be designed using accepted engineering practices shown to be effective in moving water away from the system site.
- It is crucial to ensure that the outfall of the perimeter drain remains unobstructed; openings should be screened and/or placed in stone and regularly inspected for blockage.

Note: Advanced Enviro-Septic™ Pipe is also excellent for use in constructing perimeter drains.

Plan View

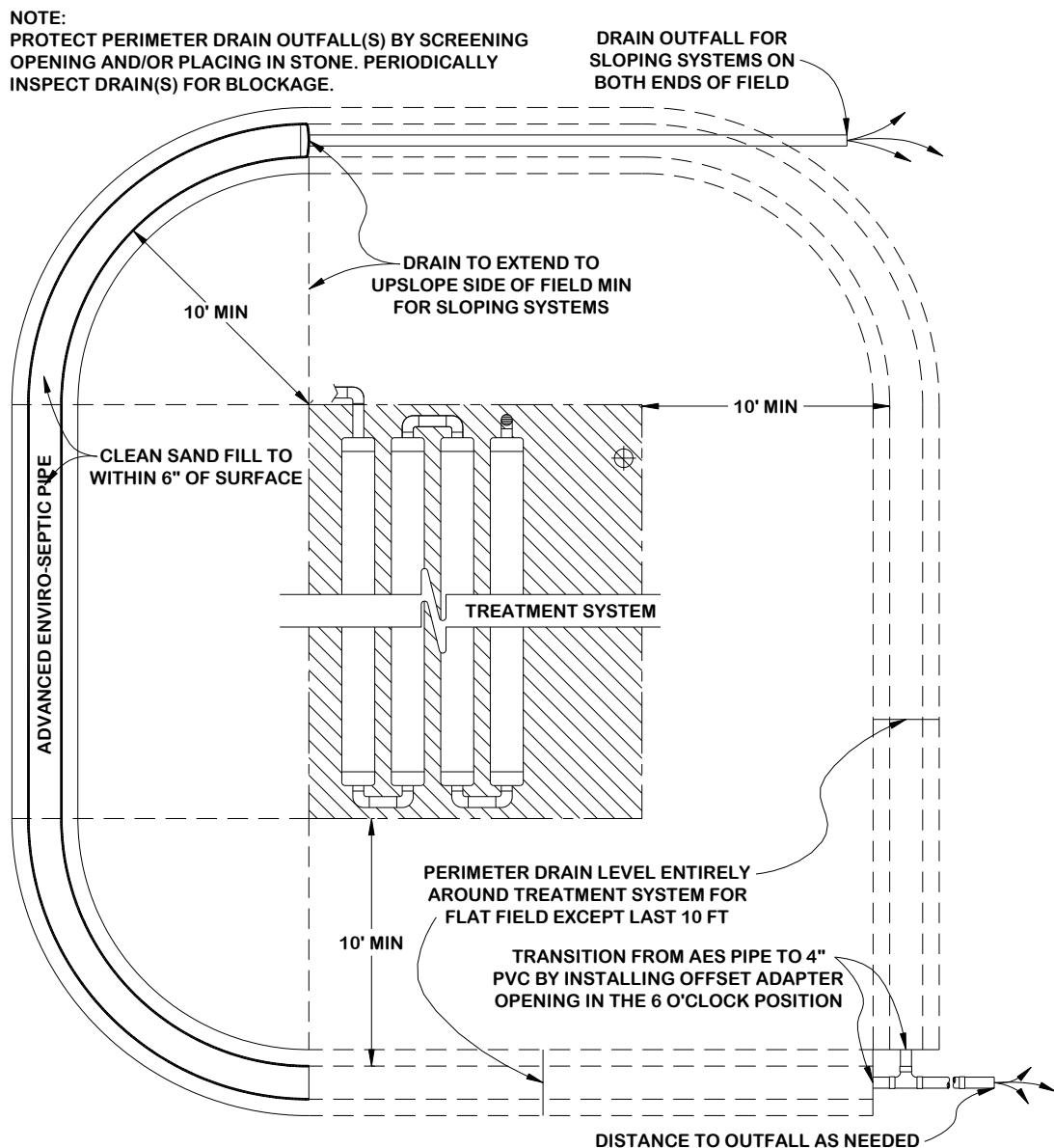

Perimeter Drains continued

Section view

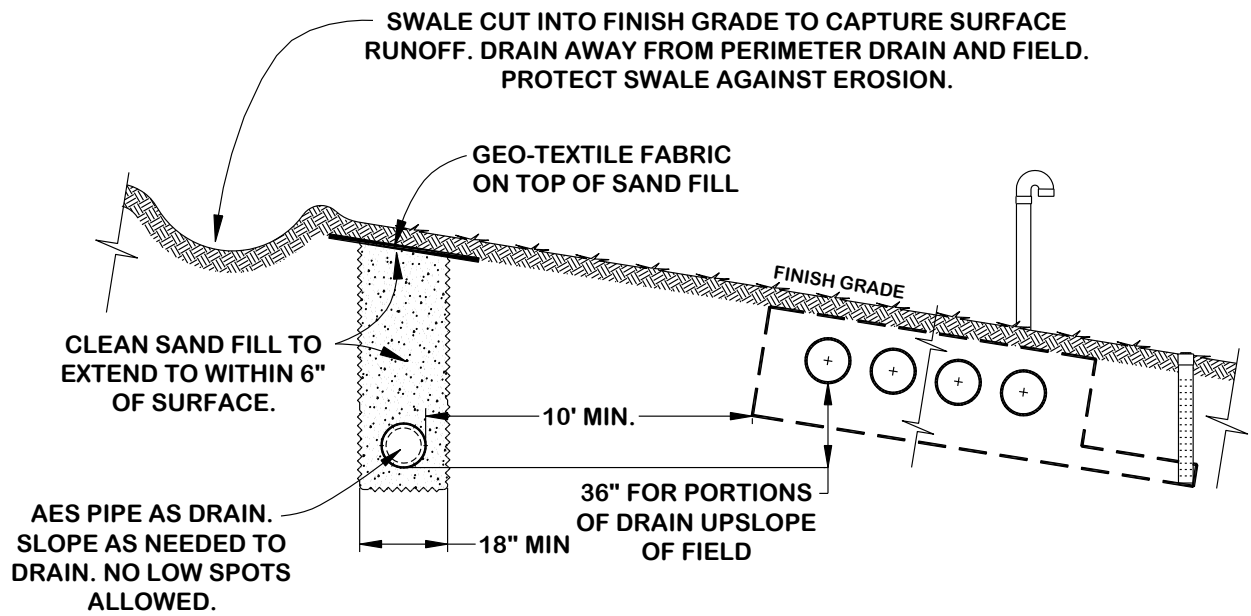

Section J Venting Requirements

General Rule

- Adequate ventilation is **essential** to the proper functioning of the Advanced Enviro-Septic™ System.
- Vent openings must be located to ensure the unobstructed flow of air through the entire Advanced Enviro-Septic™ system.
- The low vent inlet must be a minimum of 3 ft. above final grade.

Note: Vent disguises are available for purchase through PEI dealers.

When to Vent

- High and low vents are **required** for **all** systems.
 - The roof (house) vent is the “high vent” in gravity systems.
 - One 4 in. low vent is required for every 1,000 ft. of Advanced Enviro-Septic™ pipe.
 - A single 6 in. low vent may be installed instead of three 4 in. vents.
 - The diameter of the vent manifold must match the vent stack diameter.
-

Differential Venting

- Differential venting is the use of high and low vents in a system.
 - High and low vent openings must be separated by a minimum of 10 vertical ft.
 - The high and low vents should be of the same capacity.
 - Roof vent diameter must be a minimum of 3 in., 4 in. diameter is recommended. If the roof vent is less than 3 in., an additional high vent is recommended.
 - Sch. 40 PVC or equivalent should be used for all high vents.
 - Vents extending more than 3 ft. above grade must be anchored.
-

Vent Locations

Vent locations depend upon the type of system. For ease of illustration, most drawings show high and low vents on opposite ends of the field; however, high and low vents may be installed on the same end of the field as long as the 10 ft. differential between high and low vents are maintained.

Gravity Systems

- A low vent through an offset adapter is installed at the end of each row, Section or Basic Serial bed. A vent manifold may be used to connect the ends of multiple Sections or rows.
- **The house (roof) vent functions as the high vent** as long as there are no restrictions or other vents between the low vent and the house (roof) vent.

Pumped Systems

- A low vent is installed through an offset adapter at the end of each row, Section or Basic Serial bed.
- A high vent is installed through an unused D-Box outlet (see diagram on next page).
- Alternatively, the low vent may be attached to the D-Box and the high vent may be attached to the end of the last Advanced Enviro-Septic™ row. If this configuration is used in cold climates, the D-Box must be insulated to prevent it from freezing.

Venting Requirements, Continued

Differential Venting for Pump Systems (Typical – Not to Scale)

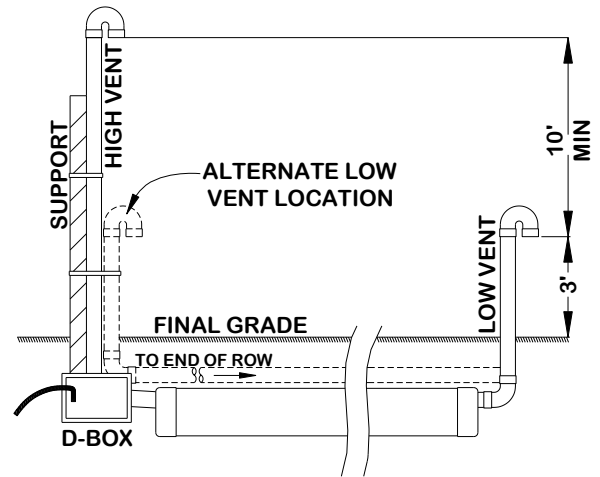

Proper gravity system vent configuration

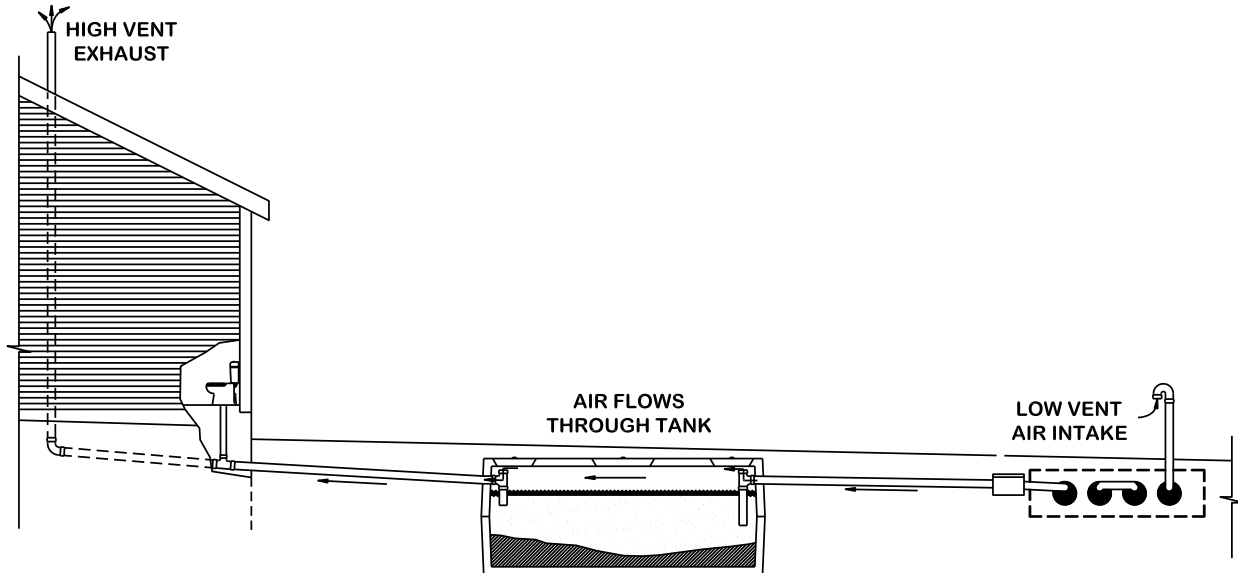

Air flow is established by the High Vent's chimney effect, which draws air into the Low Vent, through the Advanced Enviro-Septic™ pipes, through the septic tank and exhausting through the roof vent.

Venting Requirements, Continued

Vent Manifolds A vent manifold may be incorporated to connect the ends of a number of Sections or rows of Advanced Enviro-Septic™ pipe to a single vent opening. See diagram below (inspection port not shown).

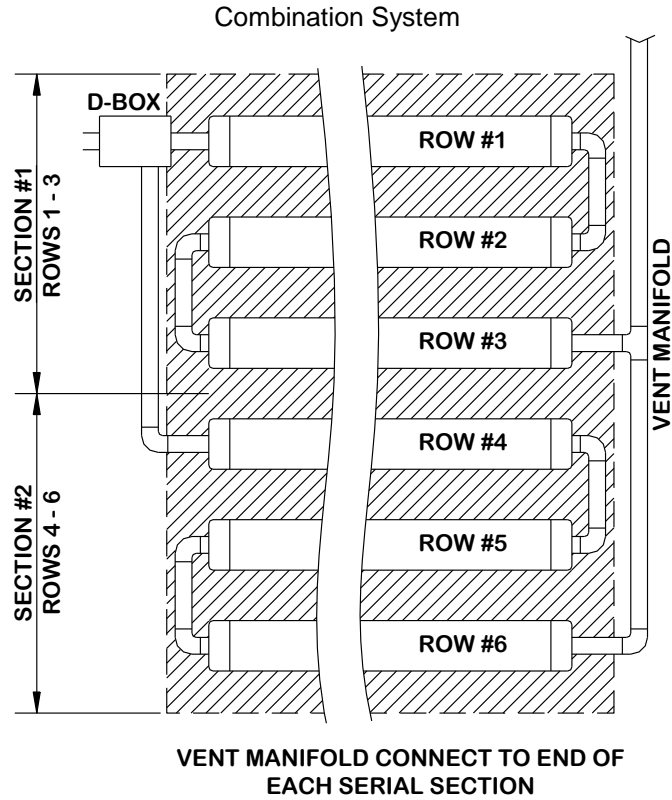

Venting Requirements, Continued

Vent Piping Slope

Vent piping should slope downward toward the system to prevent moisture from collecting in the pipe and blocking the passage of air.

Remote Venting

If site conditions do not allow the vent pipe to slope toward the system, or the owner chooses to utilize remote venting for aesthetic reasons (causing the vent pipe not to slope toward the system), the low point in the vent line must be drilled creating several 1/4 in. holes to allow drainage. This procedure may **only** be used if the vent pipe connecting to the system has:

- A **high point** that is above the highest point of the Advanced Enviro-Septic™ row or D-Box that it is connected to; and,
- A **low point** opened for drainage which is above the SHWT. (See diagram below.)

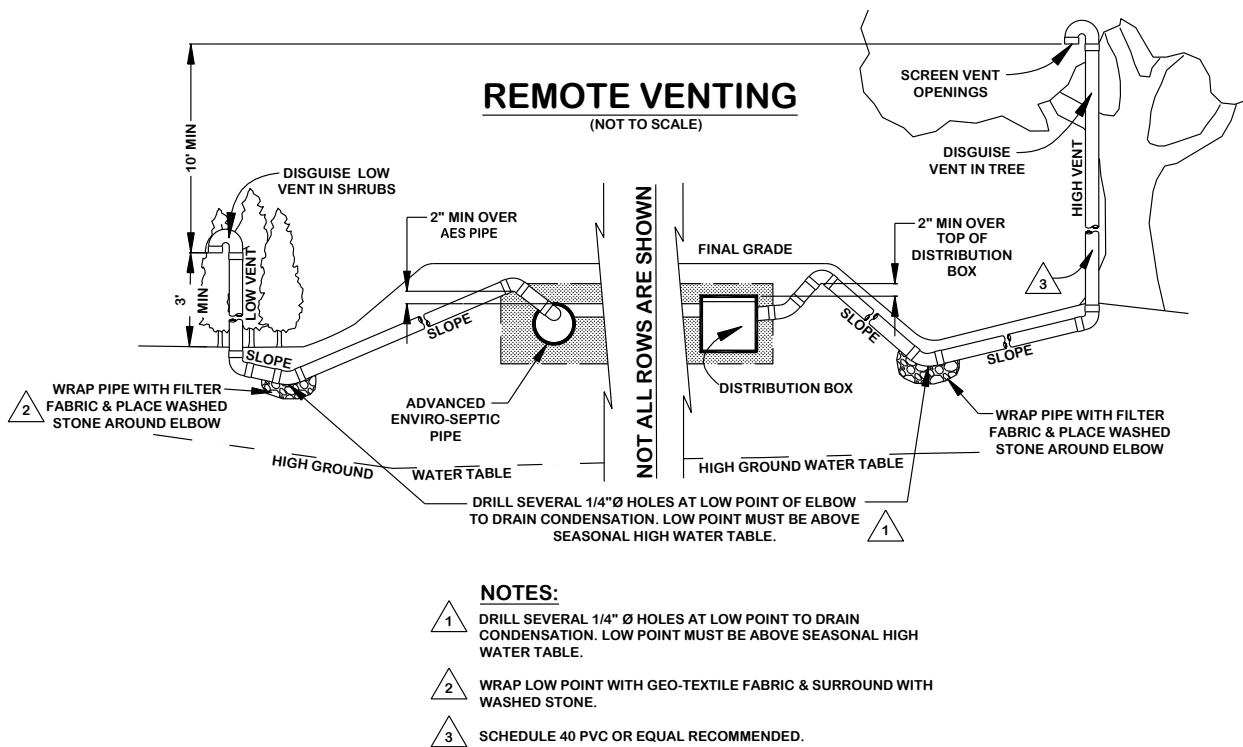

BY-PASS VENTING

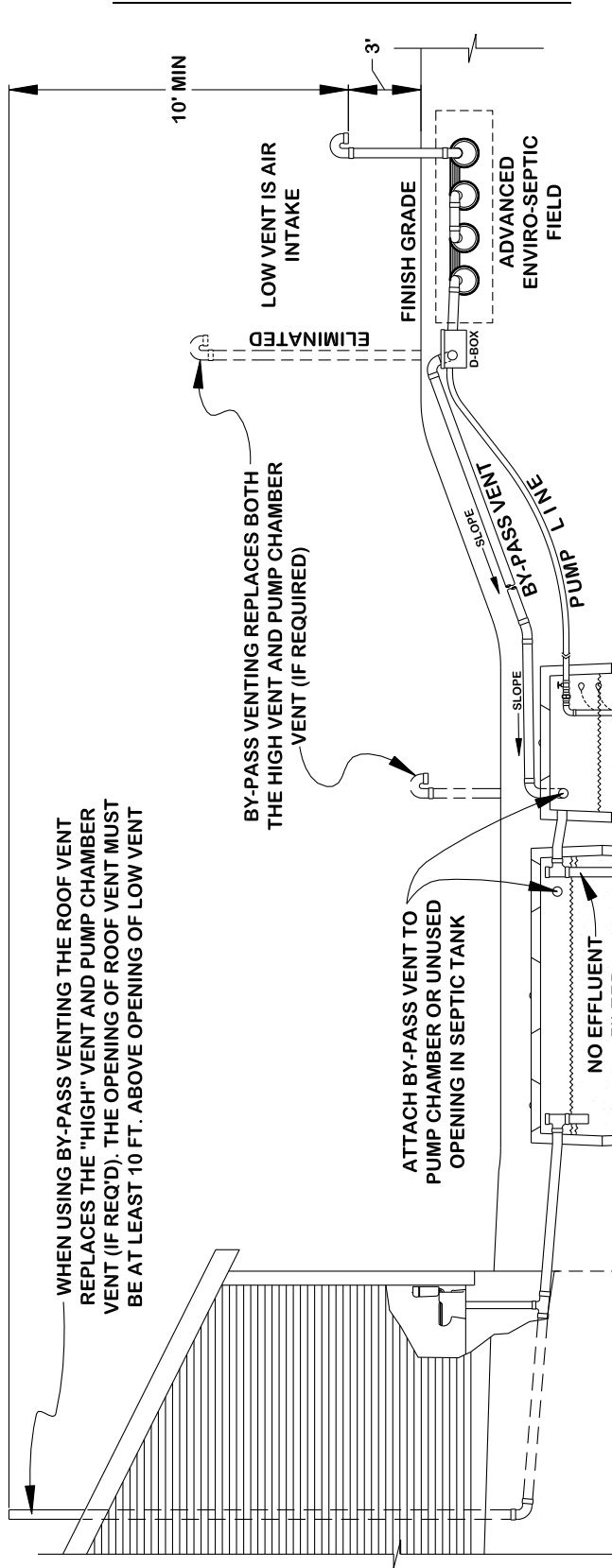

NOTES:

1. NOT TO BE USED WITH GRAVITY SYSTEMS.
2. INVERT OF PIPE EXITING D-BOX MUST BE 2" MINIMUM ABOVE D-BOX.
3. USE 4" SCH. 40 PVC OR EQUAL FOR BY-PASS VENTING.
4. GLUE ALL PVC JOINTS OR EQUAL.

OPTIONAL CONFIGURATION

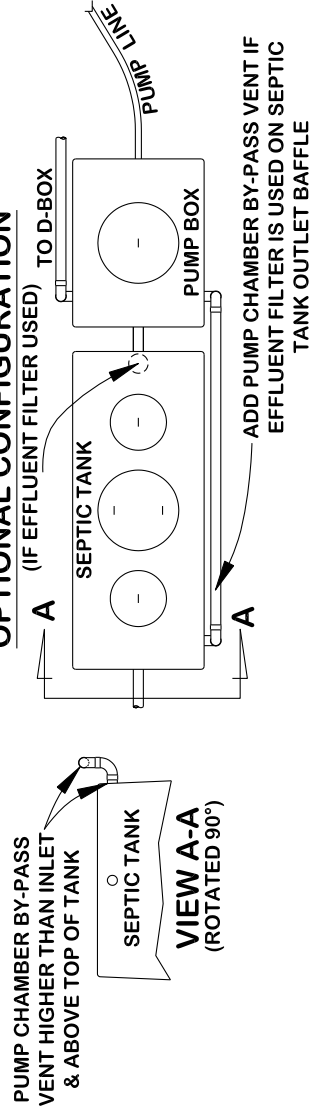

Section K Site Selection

Determining Site Suitability	In order to decide if a particular site is suitable for an Advanced Enviro-Septic™ system, measure the distance down from existing grade to the highest layer of SHWT, ledge, bedrock or impermeable soil in the soil horizon in the proposed system site and a 50 ft. perimeter. There must be a minimum of 6 in. of unsaturated soil in order to install an Advanced Enviro-Septic™ System.
Topography	Locate systems on convex, hill, slope or level locations that do not concentrate surface flows. Avoid swales, low areas, or toe-of-slope areas that may not provide sufficient drainage away from the system.
Surface Water Diversions	Surface water runoff must be diverted away from the system. Diversions must be provided up-slope of the system and designed to avoid ponding. Systems must not be located in areas where surface or groundwater flows are concentrated.
Dispersal Area	Systems must be located where adjacent soils in the proposed system location and a 50 ft. perimeter are suitable for dispersing water away from the system.
Systems under Hardscape	The State of Ohio does not permit systems to be installed under hardscape or pavement.
Containment	Systems should not be located where structures such as curbs, walls or foundations might adversely restrict the soil's ability to transport water away from the system.
Hydraulic Loading	Systems should not be located where lawn irrigation, roof drains, or natural flows increase water loading to the soils around the system.
Access	Systems should be located to allow access for septic tank maintenance and to at least one end of all Advanced Enviro-Septic™ rows. Planning for future access will facilitate Rejuvenation in the event the system malfunctions. (Refer to Section Q, Rejuvenation & Expansion, pp. 58-59).
Rocky or Wooded Areas	Avoid locating systems in rocky or wooded areas that require additional site work, since this may alter the soil's ability to accept water. No trees or shrubs should be located within 10 ft. of the system to prevent root infiltration.
Reserve Area	Since Advanced Enviro-Septic™ preserves the characteristics of the underlying soils, it is not necessary to designate a reserve area for a replacement system. Ohio State and/or Local rules require a reserve area for new construction.

Section L

System Sand and Fill Material Specifications

System Sand

The System Sand that surrounds the Advanced Enviro-Septic™ pipes is an **essential** component of the system. It helps move treated wastewater away from the system and facilitates oxygen/gas exchange. It is **critical** that the correct type and amount of System Sand is used when constructing the system. System Sand must be coarse to very coarse, clean, granular sand, free of organic matter. Manufactured sand is acceptable for use as System Sand. System Sand must meet one of the following specifications (sieve analysis from supplier recommended to confirm) :

Option 1: OH Department of Transportation (DOT) Fine Aggregate for Portland Cement Concrete (703.02) providing that no more than 2% can pass a #200 sieve (as determined by washing sample).

Option 2: ASTM C-33 (“concrete sand”) is acceptable for use as System Sand providing that no more than 2% can pass a #200 sieve (as determined by washing sample).

System Sand is placed a minimum of 12 in. below all Advanced Enviro-Septic™ pipes, a minimum of 6 in. above the Advanced Enviro-Septic™ pipes, a minimum of 6 in. between Advanced Enviro-Septic™ rows, and a minimum of 1 ft. horizontally around the perimeter of the Advanced Enviro-Septic™ pipes.

Clean Fill Material

Clean fill material is to be used to raise the elevation of the system in order to meet the required separation distance from the SHWT or other restrictive feature. It is also used in constructing side slope tapering. “Clean Fill Material” is defined as clean natural or manufactured sand, free of topsoil, organic matter or debris and containing no stones larger than 2 in.. No more than 15% of this sand shall pass through a #100 sieve and no more than 5% shall pass through a #200 sieve (as determined by washing sample).

Naturally-occurring soils removed when excavating the site may be used for constructing side slope tapering, provided the soil contains no organics, stones larger than 2 in., stumps or other debris.

Note: System Sand may be used in place of clean fill material.

Topsoil (a.k.a. “Loam”)

Suitable earth cover, similar to the naturally occurring soil at the site and capable of sustaining plant growth, is required as the uppermost layer over the entire system (and side slope tapering). The topsoil layer should be a minimum of 4 in. deep (after settling) and should be immediately seeded or mulched in order to prevent erosion.

Section M Preparing for Installation

Avoid compaction Avoid compaction of the soils in the area receiving System Sand, the side slope tapering and the area down-slope of the proposed system. Materials and equipment must not be stored or transported over the receiving soils.

Excavation procedures

- Locate machinery up-grade or alongside of the proposed system area when excavating, avoiding the system area.
- Excavate the dispersal area with a toothed bucket only. Do not excavate the dispersal area with a finish bucket because this will compact or smear the soil.
- A minimum of 6 in. of System Sand or sand fill must be installed prior to equipment traveling above the system to avoid compaction and destruction of soil structure.

Avoid Allowing Soil to Dry Dispersal area soils must not be allowed to dry. Sun or extended dry air conditions may alter soil structure. System Sand must be installed immediately following excavation of the dispersal area.

Avoid Precipitation and Erosion

- Do not excavate the system receiving area immediately after, during or prior to precipitation.
- Install sediment/erosion control barriers prior to beginning excavation to protect the system from possible surface water flows during construction.
- Warm, dry weather conditions are ideal for system installation. Check the weather forecast and schedule installation accordingly.

Avoid Excavating Frozen Soil If possible, do not excavate the soils in the system area during frozen conditions. If you have no alternative but to install the system in cold weather, be prepared to work quickly, do not allow excavated soil to cool, and install System Sand immediately. Cover the System Sand with a protective layer of insulation or hay/straw and canvas if overnight temperatures may be below freezing during the installation process (remember to remove these materials prior to backfilling).

Avoid Wet Soil Conditions Do not excavate in and around the system area when the soil is wet. If soil forms a rod 1/8 in. or less in diameter when rolled with the fingers, or if it does not crumble easily, it contains too much moisture to be worked.

Install Sand System Sand or clean fill material must be installed immediately following excavation of the system area. If it is not, repeat the "Excavation Procedures" above.

Construction Equipment Construction equipment may travel across the system area only after the installation of a minimum of 6 in. of sand fill or System Sand. If at all possible, keep equipment off the System Sand.

Preparing for Installation

Component Handling

- Keep mud, grease, oil, etc. away from all components.
 - Avoid dragging pipe through wet or muddy areas.
 - Store pipe on high and dry areas to prevent surface water and soil from entering the pipes or contaminating the fabric prior to installation.
 - The outer fabric of the Advanced Enviro-Septic™ pipe is ultra-violet stabilized; however, this protection breaks down after a period of time in direct sunlight. To prevent damage to the fabric, cover the pipe with an opaque tarp or store indoors.
-

Stake Out System Location

- Locate and stake out the System Sand bed (including System Sand extension area if needed), and areas impacted by side slope tapering on the site according to the approved plan.
- Double-check that all set-back requirements are met. Remember, horizontal set-backs are measured from the outermost edge of the Advanced Enviro-Septic™ pipe.
- Confirm that the site complies with the parameters in Section K, Site Selection, p. 47.

Section N Installation & Construction Procedures

Critical Reminder Prevent Soil Compaction

It is critical to keep excavators, backhoes, and other equipment off the excavated or tilled surface under and around where the treatment system will be located. Before installing the System Sand, excavation equipment should be operated around the bed perimeter and not on the bed itself. During all stages of installation, avoid compacting soil adjacent to the bed as much as possible.

Tree Stump Removal

- Remove all tree stumps and the central root system below grade by using a backhoe or excavator with a mechanical “thumb” or similar extrication equipment, lifting or leveraging stump in a manner that minimizes soil disturbance.
 - Do not locate equipment within the limits of the system area.
 - Avoid soil disturbance, relocation, or compaction.
 - Avoid mechanical leveling or tamping of dislodged soil.
 - Fill all voids created by stump or root removal with System Sand.
-

Raking and Tilling Procedures

All areas receiving System Sand and side slope tapering **must** have the organic layer (grass, leaves, forest litter, etc.) removed. If a backhoe/excavator is used to till the site, fit it with chisel teeth and till the site. The backhoe/excavator must remain outside of the proposed system location, including the entire System Sand bed area and all areas that will be impacted by side-slope tapering.

- Remove all organics (O soil horizon) in the footprint of the dispersal area prior to installing System Sand.
 - If the topsoil (A soil horizon) is less permeable than the soil beneath it, remove topsoil before installing System Sand, or till topsoil together with 6 in. of System Sand to create a transition layer.
-

Stone and Organic Material Removal

While tilling, remove all stones larger than 6 in., stumps, roots, grass, brush and other organic matter or debris from the excavated system site. Refer to Tree Stump Removal, above, for proper procedures for removing stumps.

Note: It is not necessary for the soil of the system site to be smooth when the site is prepared.

Installation Procedures, continued

Install System Sand and/or Fill Immediately After Excavation

- To protect the tilled area (System Sand bed area and area impacted by side slope tapering) from damage by precipitation, System Sand or sand fill should be installed immediately after tilling.
 - When installing the System Sand, work off either end or the uphill side of the system to avoid compacting soil (see "**Critical Reminder**" at the beginning of this section).
 - When installing sand, keep at least 6 in. of sand between the vehicle tracks and the tilled soil of the site.
 - Tracked construction equipment should not travel over the installed system area until at least 1 ft. of cover material is placed over the Advanced Enviro-Septic™ pipes.
 - Construction equipment with wheels/tires should not travel over the installed system area until at least 18 in. of cover material is placed over the Advanced Enviro-Septic™ pipes.
-

Row installation sequence

1. Install a minimum of 12 in. of System Sand to the elevation where the bottom of Advanced Enviro-Septic™ pipes will be, and install the sand on side slope tapering to allow machinery movement around the perimeter of the system. Rake the System Sand where the Advanced Enviro-Septic™ pipes will be installed so it is as level as possible before placing pipes on the System Sand. This will make it easier to level the pipe rows.
 2. Locate Advanced Enviro-Septic™ rows horizontally to tie points on site.
 3. Locate Advanced Enviro-Septic™ rows vertically using a laser level or transit at each coupling. Lift or lower the pipes at couplings using a hand shovel and adding or removing System Sand as necessary.
 4. Drop System Sand along each row of couplings being careful to avoid moving the rows.
 5. Add or remove System Sand along rows to level. The rows may be raised by straddling them and pushing additional System Sand below the pipes with your feet. A hand shovel may be scraped along the System Sand below the pipes to remove a small amount if needed.
 6. Re-check horizontal and vertical locations. Re-check that pipes are level to within +/- 1/2 in.
 7. Add System Sand between and around the Advanced Enviro-Septic™ pipes, leaving the uppermost surface of the pipe exposed to allow for system inspection (if required by local approving authority).
-

D-Box Installation

It is essential that the D-Box remain level after installation in order to ensure even distribution to all rows within the system. Be sure D-Boxes are placed level on undisturbed soil, compacted sand, pea gravel base, or concrete pad. Take care when backfilling that the D-Box remains level.

Level Tolerances

Use a laser level or transit to install the pipes level. Variations beyond +/- 1/2 in. may affect system performance. Variations beyond a total of 1 in. are **not acceptable**.

Installation Procedures, continued

Row Spacers

Sand may be used to keep pipe in place while covering, but simple tools may also be constructed for this purpose. Three examples are shown below.

Caution: Remove all tools used as row spacers before final covering.

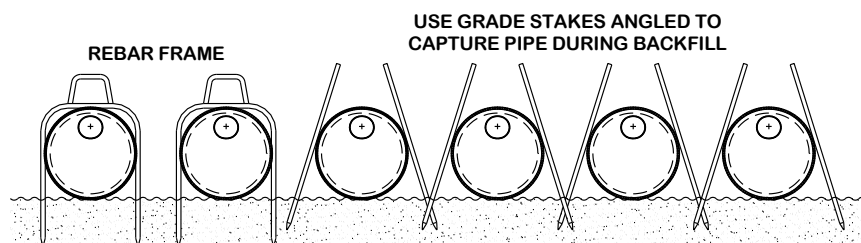
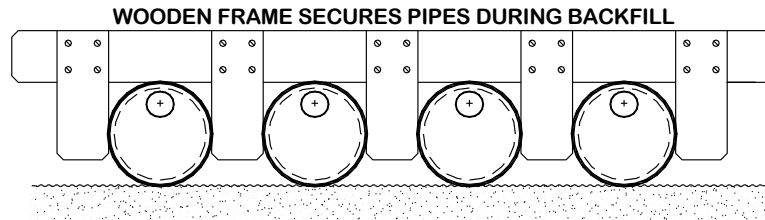

Connect Rows Using Raised Connections

Raised connections consist of offset adapters, PVC pipe, and 90° elbows. Sewer and drain pipe is recommended, Schedule 20 or 40 PVC can also be used. Raised connections enable greater liquid storage capacity within the pipes and increase the bacterial surfaces being developed. Use raised connections to connect the rows of the Advanced Enviro-Septic™ system.

Correct Placement of Raised Connections

It is essential to the proper functioning of the system that the ends of the Raised Connections extend 2 in. to 4 in. into the Advanced Enviro-Septic™ pipe. If the ends are not at least 2 in. into the pipe, they may become dislodged during backfilling. If the ends extend more than 4 in. into the pipe, this may cut off the flow of oxygen to the system. Refer to illustration below.

The top of the Raised Connections should be level with the top of the Advanced Enviro-Septic™ pipe as shown below.

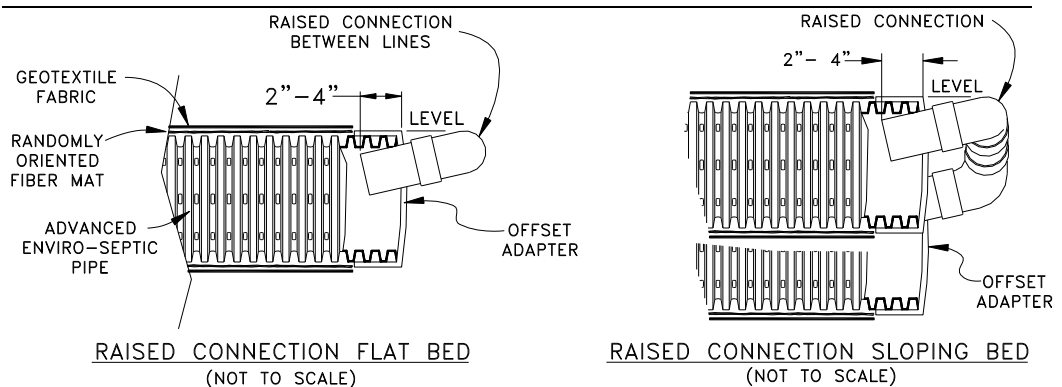

Installation Procedures, continued

Install System Sand

- Spread System Sand between the rows.
 - Straddle each row of pipe and walk heel-to-toe its entire length, ensuring that System Sand fills all void spaces beneath the Advanced Enviro-Septic™ pipe.
 - Finish spreading System Sand to the top of the pipes for inspection purposes (if required in your area).
 - Confirm that all rows of pipe are level to within +/- ½ in.
 - After inspection (if required) proceed to backfilling and final grading.
-

Inspection Port Installation

The bottom of the inspection port is located 12" below the bottom of the Advanced Enviro-Septic™ pipe. The proper placement and installation of the required inspection port is shown in the diagram below.

4"Ø PERFORATED INSPECTION PORT TO EXTEND TO BOTTOM OF SYSTEM SAND. INSTALL A THREADED CAP ON TOP OF PORT AND BRING TO WITHIN 3" OF FINAL GRADE. WRAP PIPE WITH PERMEABLE GEOTEXTILE FABRIC TO ELIMINATE SAND INFILTRATION.

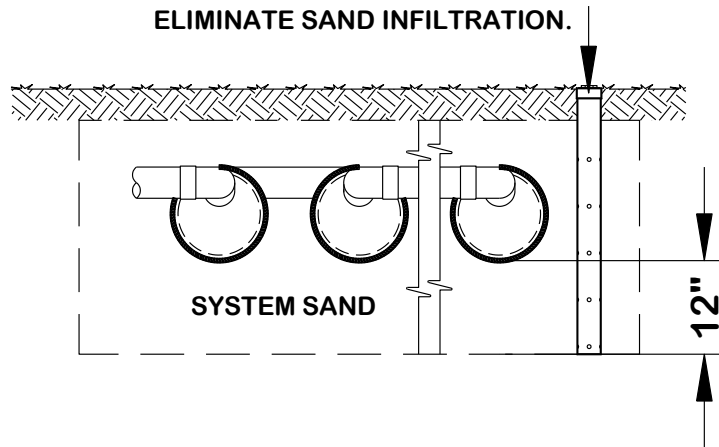

Section O Final Grading

Side-Slope Tapering

To prevent erosion, all Advanced Enviro-Septic™ systems with any part of the system (including cover material) above original grade require side slope tapering on each side beyond the outer edge of the System Sand bed, tapering to a 3:1 slope.

Install Remaining 6 in. of System Sand

After the installed system has been inspected (if required by local approving authority), install 6 in. of System Sand above the pipes. DO NOT install any barrier materials on top of the System Sand.

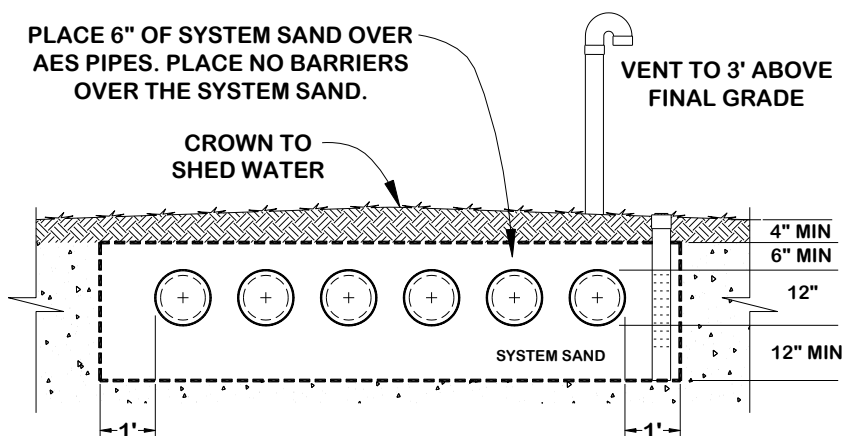

Final Grading

Final grading of the entire site should redirect surface water flows so that they do not collect in the system bed area. The system bed must slope or have a crown to ensure that surface water runoffs do not collect on the system. Systems should not be located where lawn irrigation, roof drains, or natural flows increase water loading to the soils around the system.

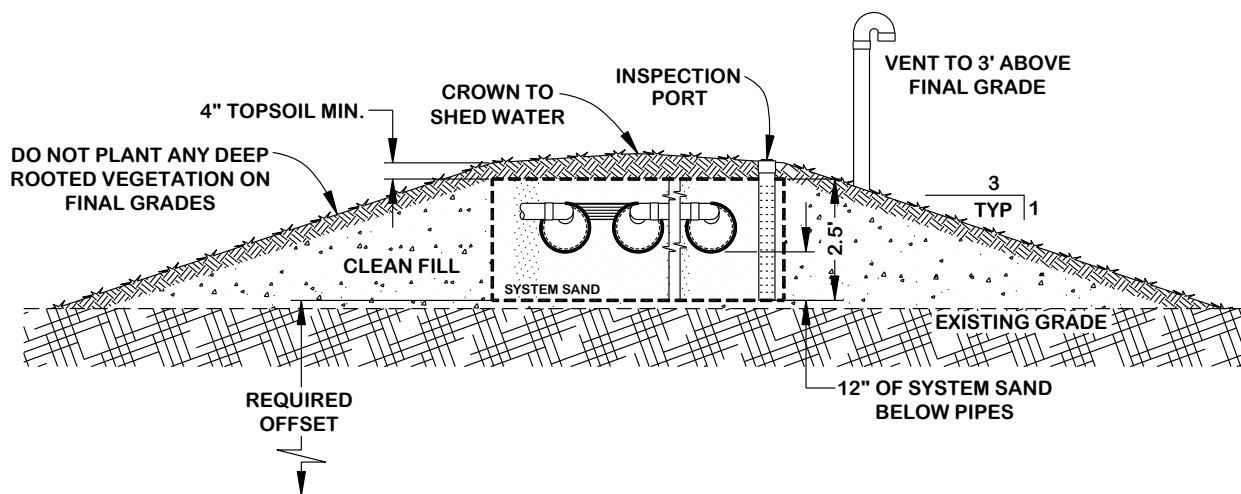

Final Grading, Continued

Erosion Control Construct and maintain surface diversions, swales, grading, silt fence, seeding and mulching to minimize concentration of surface water flows and erosion.

Cover Requirements A minimum of 4 in. (after settling) of topsoil (loam) capable of supporting plant growth is required over the System Sand or sand fill.

Mulch or Seed Immediately apply mulch or seed with grass, wildflowers or other shallow-rooted native vegetation to prevent erosion of the system bed.

What Not to Plant No trees or shrubs should be located on or within 10 ft. of the system perimeter (including side slope tapering) to prevent roots from growing into and damaging the system. Do not plant gardens for human consumption in the vicinity of the wastewater treatment system.

Section P Operation & Maintenance

Proper Use

The Advanced Enviro-Septic™ Wastewater Treatment System requires minimal maintenance provided the system is not subjected to abuse. An awareness of proper use and routine maintenance will guarantee system longevity. We encourage all system owners and service providers to obtain and review a copy of our Owner's Manual, available from our website www.PresbyEnvironmental.com or via mail upon request to (800) 473-5298 or info@presbyeco.com.

System Abuse

The following conditions constitute system abuse:

- Liquid in high volume (excessive number of occupants, excessive use of water in a short period of time, leaking fixtures, whirlpool tubs, hot tubs, water softening equipment or additional water discharging fixtures if not specified in system design).
- Solids in high volume (excessive number of occupants, paper products, personal hygiene products, garbage disposals or water softening equipment if not specified in system design)
- Antibiotic medicines in high concentrations
- Cleaning products in high concentrations
- Fertilizers or other caustic chemicals in any amount
- Petroleum products in any amount
- Latex and oil paints
- System suffocation (compacted soils, barrier materials, etc.)

Special Note: Presby Environmental, Inc., and most regulatory agencies do not recommend the use of septic system additives.

System Maintenance/ Pumping of the Septic Tank

- Inspect the septic tank at least once every two years under normal usage.
 - Pump the tank when surface scum and bottom sludge occupy one-fourth or more of the liquid depth of the tank.
 - If a garbage disposal is used, the septic tank will likely require more frequent pumping.
 - After pumping, inspect the septic tank for integrity to ensure that no groundwater is entering it. Also check the integrity of the tank inlet and outlet baffles and repair if needed.
 - Inspect the system to ensure that vents are in place and free of obstructions.
 - Effluent filters are not recommended because of their tendency to clog and cut off oxygen to the system. If a filter is used, it will require diligent maintenance and cleaning to prevent it from becoming clogged. Follow filter manufacturer's maintenance instructions and inspect filters frequently.
-

Site Maintenance

It is important that the system site remain free of shrubs, trees, and other woody vegetation to within a minimum of 10 ft. of the system, including the entire System Sand bed area, and areas impacted by side slope tapering. Roots can infiltrate and cause damage or clogging of system components.

Section Q Rejuvenation & Expansion

Introduction	<p>This section provides an overview of bacteria rejuvenation and explains how to expand existing systems. These procedures may only be used with Advanced Enviro-Septic™ systems; it is difficult or impossible to rejuvenate other systems. The local approving authority must be contacted and permits obtained if required prior to Advanced Enviro-Septic™ system rejuvenation, expansion, or replacement. Please contact PEI at 800-473-5298 for technical assistance before attempting rejuvenation procedures.</p>
What is Bacteria Rejuvenation?	<p>Bacteria rejuvenation is the return of bacteria to an aerobic state. Flooding, improper venting, alteration or improper depth of soil material cover, use of improper sand instead of System Sand, introduction of chemicals or medicines, and a variety of other conditions can contribute to converting bacteria in the Advanced Enviro-Septic™ pipe from an aerobic to an anaerobic state. This conversion severely limits the bacteria's ability to effectively treat effluent, as well as making it more difficult for wastewater to pass through.</p>
How to Rejuvenate Bacteria	<p>System bacteria are "rejuvenated" when they return to an aerobic state. By using the following procedure, this can be accomplished in most systems without costly removal and replacement.</p> <ol style="list-style-type: none">1. Determine and correct the problem causing the bacteria conversion.2. Excavate one end of each row and remove the offset adapters.3. Have system and septic tank pumped by a registered septage pumper.4. Safeguard the open excavation.5. Guarantee a passage of air through the system.6. Allow pipes to dry for a minimum of 72 hours. When the System Sand around the pipes returns to its natural color, this is an indication that the conversion to aerobic conditions has taken place.7. Re-assemble the system to its original design configuration. As long as there is no damage to the Advanced Enviro-Septic components, the original components may be reused. <p><u>Note:</u> Contact Presby Environmental, Inc., for more detailed instructions before attempting to rejuvenate an Advanced Enviro-Septic™ system.</p>
System Expansion	<p>Advanced Enviro-Septic™ systems are easily expanded by adding equal lengths of pipe to each row of the original design, or by adding additional equal Sections, or by adding additional beds. Check with the appropriate approving authority to determine if a permit is required.</p>
Reusable Components	<p>Advanced Enviro-Septic™ components are not biodegradable and may be reused. In cases of improper installation it may be possible to excavate, clean, and reinstall all system components.</p>

Rejuvenation and Expansion of Advanced Enviro-Septic™ Systems, continued

System Replacement

If an Advanced Enviro-Septic™ system requires replacement...

- It can be replaced in the same location.
- Remove the existing components and contaminated sand
- If the soils under and around the system have not been compromised, replace in the same excavated location with new System Sand.
- If components are not damaged, they may be reused.

Note: Permits are required for system replacement.

Appendix A

Ohio Advanced Enviro-Septic™ System Installation Form

Installers must complete and fax or mail a copy of this form to the local approving authority and to: Presby Environmental, Inc., 143 Airport Rd, Whitefield, NH 03598
 Fax: (603) 837-9864 or complete online at www.PresbyEnvironmental.com

Please print or type information

Installer's Name:		Installer's PEI Certification Number:	
Company Name:			
Street Address:			
City:		State:	Zip:
Installer's Phone Number:			
Designer's Name:		Company Name:	
Street Address:			
City:		State:	Zip:
Phone Number:			
Property Owner(s):			
Site Street Address:			
City:		State:	Zip:
System Information <i>(check all that apply):</i>			
<input type="checkbox"/> New Construction <input type="checkbox"/> Replacement <input type="checkbox"/> Mound <input type="checkbox"/> In ground <input type="checkbox"/> Gravity			
<input type="checkbox"/> Pump to D-Box <input type="checkbox"/> Serial Distribution Number of Beds: _____			
<input type="checkbox"/> Effluent Filter Used Design Flow (bedrooms or gpd): _____			
Installation Date:		System Startup Date:	
Construction Permit Number:			
Comments:			

APPENDIX B

Advanced Enviro-Septic™ Wastewater Treatment System - Ohio Installation Checklist

Manufactured by Presby Environmental, Inc. (800) 473-5298 Distributed in OH by Environmental Septic Solutions (812) 457-3144

System Owner: _____ **Site Address:** _____

Instructions to Installer: Check box in left column to confirm each installation requirement has been met.

√	INSTALLATION REQMTS.	COMMENTS	REFERENCE
	Installation performed during appropriate weather conditions	Not installed on wet or frozen ground; protect against freezing; system covered with System Sand and cover material immediately after inspection.	Manual, Section M, Preparing for Installation, pp.49-50
	Proper site preparation before installation	No heavy equipment on system area and dispersal area; no scraping, compacting or smearing of receiving soils; excavated using toothed bucket only; "O" horizon (organics) removed from dispersal area. If topsoil ("A horizon") is less permeable than underlying soil, remove OR till topsoil together with 6 in. of System Sand to create transition layer.	Manual, Section N, Installation & Construction Procedures, pp.51-54
	Trees/Stumps in system location	Remove all stumps/root systems using mechanical "thumb" to minimize soil disturbance. Fill voids with System Sand.	Manual, Section N, Installation & Construction Procedures, pp. 51-54
	Correct System location	Confirm elevations and set-backs per plan; not located where surface or ground waters converge; designed and installed along contour; note any discrepancies or changes approved by local health department on "as built" plan; sketch system location on sheet provided, making reference to structures or benchmarks and indicating any "as-built" changes; provide copy of sketch to system owner.	Manual, Section K, Site Selection, p. 47
	System Sand meets specs.	OH DOT Fine Aggregate OR ASTM C-33 w/ less than 2% fines. Confirm with sieve analysis from supplier (optional).	Manual, Section L, System Sand and Fill Materials Specs., p. 48
	Correct Amount of System Sand installed	12 in. below pipes 6 in. minimum between rows 6 in. above pipes 12 in. horizontally beyond outer perimeter of pipes Incorporate System Sand extensions if req'd. 6 in. deep in System Sand extensions	Manual, Section L, System Sand and Fill Material Specs. p. 48
	Offset/Double Offset Adapters installed correctly	Hole in the 12 o'clock position	Manual, Section B, AES Components, pp. 5-7
	Raised Connections installed correctly	Extend no less than 2 in. and no more than 4 in. into Offset/Double Offset Adapter; angled so that top of Connection is level with top of pipe.	Manual, Section N, Installation & Construction Procedures, pp. 51-54
	Alignment of Advanced Enviro-Septic™ pipes is correct	Approximately parallel (to within +/-1 in.) and level (to within +/- 1/2 in.)	Manual, Section E, General Design Criteria, pp. 26-31
	D-Box installed correctly (if used/required)	On stable base; level; flow equalizers installed and adjusted; unused outlets plugged/mortared; seals watertight; minimum 2 in. drop in elevation from D-Box to AES pipes; tee baffle required in D-Box	Manual, Section N, Installation & Construction Procedures, pp. 51-54
	Septic Tank installed properly	Sized sufficiently in relation to daily design flow; watertight and structurally sound; inlet and outlet baffles in place; all access covers, risers, etc. sealed; connecting PVC from tank to D-Box or pipes slopes at least 1%.	Manual, Section B, AES Components, pp. 5-7 and Section E, General Design Criteria, p. 29
	Inspection Ports installed properly	Constructed of 4 in. perforated PVC with threaded cap on top accessible at grade. Wrap pipe with permeable geotextile fabric to prevent System Sand infiltration. Bottom of Inspection Port to be 12 in. below AES pipe, at the System Sand/Soil interface. One Inspection Port per bed req'd.	Manual, Section N, Installation & Construction Procedures, pp. 51-54

√	INSTALLATION REQUIREMENTS	COMMENTS	REFERENCE
	Perimeter drain properly installed (if included in design)	Encircles system on 4 sides; constructed of perforated minimum 4 in. approved drain pipe w/ geo-textile sleeve; minimum 10 ft. from outer edge of System Sand bed(s); clean fill to w/in 6 in. of final grade; installed with a positive slope of at least 0.2 ft. per 100 ft. with no sags in the line. Install screen at outlet to prevent animal nesting. Instruct system owner not to alter swales & explain importance of ongoing maintenance to ensure outlet is unobstructed.	Manual, Section I, Perimeter Drains, pp. 40-41
	Venting Properly installed	Venting is REQUIRED for all systems. High vent off the D-Box is required for pumped systems, 10 ft. differential req'd. between low & high vent openings. House/roof vent will be "high" vent in gravity systems. Low vent inlet to be min. 3 ft. above final grade. One 4 in. vent req'd. for every 1,000 ft. of pipe.	Manual, Section J, Venting Requirements, pp. 42-46
	No excess hydraulic loading	NO floor drains, roof drains, foundation drains, sump pumps, gutter systems, irrigation systems, etc. discharging in system area.	Manual, Section K, Site Selection, p. 47
	Discharges from water treatment systems, water softeners/purifiers, hot tubs, jetted tubs, etc.	Seek an alternative means of dispersal.	Manual, Section E, General Design Criteria, pp. 26-31
	Sufficient cover material installed	Minimum 4 in. firmly packed topsoil capable of sustaining vegetative growth; immediately mulch/seed to prevent erosion. NO pavement or other hardscape above system; no trees w/in 10 ft. of system; plant only grass or wildflowers.	Manual, Section O, Final Grading, pp. 55-56
	Cover material crowned	Crown from the center to direct surface water flows away from the system.	Manual, Section O, Final Grading, pp. 55-56
	Surface diversions ("Swales") properly constructed	Located to intercept and divert surface water away from the system; located in undisturbed soil; min. 10 ft. away from bed (if no perimeter drain) or above/upslope of perimeter drain with a minimum positive slope of 0.2 ft. per 100 ft.; instruct system owner not to alter or remove swales.	Manual, Section O, Final Grading, pp. 55-56
	Side slopes properly constructed	Req'd. if top of System Sand bed is above original grade	Manual, Section O, Final Grading, pp. 55-56
	Pumped System Dosing schedule	Adjust pumps so that pumping frequency is a minimum of design flow ÷ 6.	Manual, Section H, Pumped System Reqmts., p. 39
	System Installation Form	Completed and mailed to Presby Environmental.	Manual, Appendix B
	Use & Care Instructions	Inform System Owner of availability of Owner's Manual @ www.presbyeco.com . Review maintenance instructions with owner.	

By signing below, I confirm that I have followed the installation guidelines set forth above and I have provided a copy of this completed form to the system owner.

Installed by: _____
(Print Name)

Date(s) of Installation: _____

Signed: _____

PEI Certification Number: _____

APPENDIX C

Advanced Enviro-Septic™ Wastewater Treatment System Site Inspection Report (OH)			
www.PresbyEnvironmental.com		Presby Environmental	
		(800) 473-5298	
System Owner(s): Property Address: Mailing Address: Preferred phone #: Email:		PEI Certified System Evaluator: PEI Cert. #: Address: Preferred phone # : Email:	
Operational Approval Date	____ / ____ / ____	Date of Inspection	____ / ____ / ____
Permit/Approval Number		Copy of Plan Available?	Yes No
Designer: Name: Company: Address: Telephone: Email:		Installer: Name: Company: Address: Telephone: Email:	
Primary Reason for System Inspection: Person Initiating Contact: _____ Person Responsible for Fee: _____			Is System in Failure? YES NO
System Owner Interview: <i>Notes:</i>	Understanding of Req'd. Use and Maintenance?		YES NO
	Maintenance Performed as needed?		YES NO
	Any changes/additions/repairs/leaks in plumbing fixtures?		YES NO
	Vacancy, Seasonal, Intermittent or Exceptional (Over) Use?		YES NO
	Water Softener discharging to septic system?		YES NO
	Hot Tub/Jetted Tub discharging to septic system?		YES NO
	Garbage Disposal being used?		YES NO
Plan Review/System Data <i>Notes:</i>	Daily Design Flow / Hydraulic Capacity:		# of Bedrooms: _____ _____ GPD
	Elevated (Mound) or Subsurface (circle one)	% of Slope: _____%	Perc Rate or Soil Type Experimental Concurrence? YES NO
	System Dimensions / System Sand Bed Size in square feet		_____ sq. ft.
	Total feet of AES pipe:		Required: _____ ft. Provided: _____ ft.
	Number of Rows		Number of Beds
	Center-to-Center Spacing	Required: _____ in. Provided: _____ in.	Distance to SHWT or restrictive layer _____ in.
	Pumped System or Gravity Distribution? (circle one)		New Construction or Repair/Replacement/Remedial (circle one)
	Describe any waivers from Approving Authorities or PEI (if any, if known):		
	Bed Configuration: Basic Serial Combination D-Box/Parallel Non-Conventional (circle one)		
	Septic Tank: <i>Notes:</i>	Septic Tank Volume	_____ gallons
Tank Constructed of: Concrete Metal Cement Plastic Other: _____			
Tank Shape: Rectangular Round Square Other: _____			
Pumping Needed?		YES NO	Date of Last Service ____ / ____ / ____
Effluent Filter used?		YES NO	Filter Condition (circle one) CLEAN CLOGGED

Septic Tank (continued) Notes:	Sludge, Scum & Liquid Levels noted:					
	Any problems noted by septic pumper?					
	Septic Tank Capacity:	_____ gallons				
	Assessment of Structural Integrity of Tank, Covers and Risers:	PASS		FAIL		
	Assessment of Infiltration/Exfiltration (Watertightness):	PASS		FAIL		
	Assessment of connecting pipes from structure:	PASS		FAIL		
	Assessment of Inlet & Outlet Baffles:	PASS		FAIL		
	Is System pumped?	YES	NO	Pump Chamber	_____ gallons	
Pumping Frequency	_____ times/day		Pump Chamber Vented?	YES	NO	
Distribution Box Notes:	D-Box Used?	YES	NO	D-Box Level?	YES	NO
	Number of Inlets:			Number of Outlets:		
	Flow Equalizers used?	YES	NO	Flow Equalizers set correctly?	YES	NO
	D-Box vented?	YES	NO	Sized Correctly?	YES	NO
	2 in. drop to E-S pipes?	YES	NO	Inlet pipes in place and no leaks?	YES	NO
	Solids or wastes observed in D-Box?	YES	NO	D-Box structurally sound?	YES	NO
Advanced Enviro-Septic™ System Notes:	Inspection Ports Observations:					
	Perimeter Drain Observations (if present):					
	Field Level end-to-end to within + / - ½ inch				PASS	FAIL
	No offensive odors				PASS	FAIL
	No back-up of wastewater into plumbing fixtures				PASS	FAIL
	No trees, shrubs, deep-rooted plants w/in 10 ft. of System				PASS	FAIL
	No unusual vegetation color/growth above treatment field				PASS	FAIL
	Correct amount/type of cover material/mulching/seeding				PASS	FAIL
	Proper surface diversions and crowning				PASS	FAIL
	No evidence of heavy traffic over field				PASS	FAIL
Venting System Notes:	Venting in place?	YES	NO	Repairs needed?	YES	NO
	Low vent 3 ft. above final grade (min.)	YES	NO	10 ft. differential high/low vent?	YES	NO
	Differential Venting Required?	YES	NO	Vents unobstructed and intact?	YES	NO
	Remote Vented?	YES	NO	Filters on vents:	YES	NO
	Draft Test done?	YES	NO	Draft Test result:	PASS	FAIL
	System Sand Notes:	Sand appears clean?	YES	NO	Discoloration noted around pipes?	YES
Sufficient System Sand below pipes?		YES	NO	Sufficient System Sand btwn. Rows?	YES	NO
Sufficient System Sand above pipes?		YES	NO	System Sand 1 ft. around perimeter?	YES	NO
Sample obtained?		YES	NO	Sieve An analysis	PASS	FAIL
Overall Evaluation of System Function (describe)						
Repairs or Remedial Procedures Recommended (if any)						
Evaluator's Signature: _____ Dated: ____ / ____ / ____ Please send copy of completed form to: Presby Environmental, 143 Airport Road, Whitefield, NH 03598						

Glossary

Introduction	This Manual contains terminology which is common to the industry, and terms that are unique to Advanced Enviro-Septic™ systems. While alternative definitions may exist, this section defines how these terms are used in this Manual.
Advanced Enviro-Septic™ Pipe	An <u>Advanced Enviro-Septic™ pipe</u> is a single unit comprised of corrugated pipe, fiber mat and fabric, 10 ft. in length, with an outside diameter of 12 in. and a storage capacity of approximately 60 gallons. Pipes joined together form a “row.” (See definition below.)
Advanced Enviro-Septic™ System	An <u>Advanced Enviro-Septic™ system</u> is an onsite wastewater treatment and dispersal system constructed using Advanced Enviro-Septic™ pipe in a System Sand bed that receives septic tank effluent through Basic Serial distribution, Combination Serial distribution, or Multiple Bed distribution.
Basic Serial Distribution	<u>Basic Serial distribution</u> incorporates rows in serial distribution in a single bed. Basic Serial distribution is described in detail on pp.11-12.
Butterfly System	A <u>Butterfly System</u> is a variation of a standard, single bed system with the Distribution Box located in the center, rows oriented symmetrically on either side, with each side receiving an equal volume of flow from the D-Box.
Center-to-Center Spacing	<u>Center-to-center spacing</u> is the distance from the center of one Advanced Enviro-Septic™ row to the center of the adjacent row.
Clean Fill	<u>Clean fill</u> is soil material with specific textural criteria that is used in the process of system construction and/or to enhance surface water diversion. Complete information about fill material specs. can be found in Section L, System Sand and Fill Material Specifications, p. 48.
Combination Serial Distribution	<u>Combination Serial distribution</u> incorporates two or more sections of Advanced Enviro-Septic™ rows in a single bed, each section receiving a maximum of 600 GPD of effluent from a distribution box. Combination Serial distribution is explained in detail on pp. 13-14.
Contour	<u>Contour</u> is a line connecting points of equal elevation on the surface of the earth.
Coupling	A <u>coupling</u> is a fitting that joins two pieces or more within the same row of Advanced Enviro-Septic™ pipe.
Daily Design Flow	<u>Daily Design flow</u> is the peak daily flow of wastewater to a system, expressed in gallons per day (GPD); systems are typically sized based on the design daily flow. In Ohio, daily design flow is calculated by multiplying the number of bedrooms by 120 gallons per day. Note that “design flow” represents system’s maximum capacity, not the actual expected amount of average daily usage.

Glossary

Differential Venting	<u>Differential venting</u> is a method of venting an Advanced Enviro-Septic™ system utilizing high and low vents. Venting requirements are described in detail in Section J, Venting Requirements, pp. 42-46.
Distribution Box or “D-Box”	A <u>distribution box</u> (also called a “D-Box”) is a device designed to distribute effluent from an inlet pipe (from the septic tank) and equally distribute it to the outlet pipes which connect into the Advanced Enviro-Septic™ system.
End-to-End Configuration	An <u>end-to-end</u> configuration consists of two or more beds constructed in a row (i.e., aligned along the width of the beds). See drawing on p.14.
Flow Equalizer	A <u>flow equalizer</u> is an adjustable plastic insert installed in the outlet pipes of a distribution box to equalize effluent distribution to each outlet.
GPD	<u>GPD</u> is an acronym for <u>Gallons Per Day</u> .
GPM	<u>GPM</u> is an acronym for <u>Gallons Per Minute</u> .
High and Low Vents	<u>High and low vents</u> are pipes used in differential venting. Detailed information about ventilation requirements can be found in Section J, Venting Requirements, pp. 42-46.
ILR	<u>ILR</u> is an acronym for Infiltrative Loading Rate, a numerical indication of a soil’s hydraulic capacity, expressed in gallons per day per square foot, which is indicated on the Advanced Enviro-Septic™ System Sizing, Section C, p. 8-9.
Infiltrative Distance	<u>Infiltrative distance</u> is the vertical distance from the bottom of the infiltrative surface to the top of the limiting layer.
Infiltrative Surface	<u>Infiltrative surface</u> is the surface used for the absorption of treated wastewater by the soil. This is the interface between the System Sand or Surrounding Sand and the prepared soil.
Multiple Bed Distribution	<u>Multiple bed distribution</u> incorporates two or more beds, each bed with Basic Serial or Combination Serial distribution and receiving effluent from a distribution box. Multiple Bed distribution is described in detail on pp. 16-18.
Offset Adapter	An <u>offset adapter</u> is an end cap fitted with a 4in. offset hole installed at the 12 o’clock position which allows for connections from one row to another and for installation of venting.

Glossary

Pressure Distribution	<p><u>Pressure Distribution</u> is a pressurized, small-diameter pipe system used to deliver effluent to an absorption field. Pressure Distribution is not permitted to be used with the Enviro-Septic[®] system. Advanced Enviro-Septic[™] Wastewater Treatment System is designed to promote even distribution by passive means.</p>
Pumped Systems	<p><u>Pumped Systems</u> utilize a pump to gain elevation in order to deliver effluent to a distribution box. Detailed information about pumped systems can be found in Section H, Pumped System Requirements, p. 39.</p>
Raised Straight Connection	<p>A <u>raised straight connection</u> is a PVC pipe arrangement used to connect rows oriented along the contour of the site to maintain the proper liquid level inside each row. See Section B, Advanced Enviro-Septic[™] System Components, pp.5-7.</p>
Raking and Tilling	<p><u>Raking and Tilling</u> refers to methods of preparing the dispersal area that will be covered with System Sand or Surrounding Sand, creating a transitional layer between the sand and the soil. Detailed information about raking and tilling procedures can be found in Section N, Installation & Construction Procedures, pp. 51-54.</p>
Required Offset	<p><u>Required Offset</u> refers to the required minimum separation distance to ground water or other restrictive soil features. This is measured from 12 in. below the pipes at the System Sand/soil interface.</p>
Row	<p>A <u>row</u> consists of a number of Advanced Enviro-Septic[™] pipes connected by couplings with an offset adapter on the inlet end and an offset adapter on the opposite end. Rows are typically between 30ft. and 100ft. long.</p>
Section	<p>A <u>Section</u> is a group of rows receiving effluent from one distribution box outlet.</p>
Serial Distribution	<p><u>Serial distribution</u> is two or more Advanced Enviro-Septic[™] rows connected by a raised connection. Basic Serial distribution is described in detail on pp. 11-12, Combination Serial distribution is described in detail on pp. 13-14.</p>
SHWT	<p><u>SHWT</u> is an acronym for <u>S</u>easonal <u>H</u>igh <u>W</u>ater <u>T</u>able.</p>
Slope	<p><u>Slope</u>, expressed as a ratio, is a quotient of the horizontal distance and the difference in elevation between two points on the surface of a landform. This is commonly expressed as a ratio of run to rise. <u>Example</u>: A fill-slope with a grade of three to one (3:1) is the difference in horizontal distance of three (3) feet (run) over an elevation difference of one (1) foot (rise). <u>Slope</u>, expressed as a percent, is the difference in elevation divided by the difference in horizontal distance between two points on the surface of a landform. <u>Example</u>: A site slope of one (1) percent is the difference in elevation of one (1) foot (rise) over a horizontal distance of one hundred (100) feet (run).</p>

Glossary

Smearing	<u>Smearing</u> is the mechanical sealing of soil air spaces along an excavated, tilled or compressed surface. This is also referred to as “compacting.” In all installations, it is critical to avoid smearing or compacting the soils under and around the Advanced Enviro-Septic™ system.
Soil	<u>Soil</u> is naturally-occurring mineral and/or organic matter found on the surface of the system site.
Structure	<u>Structure</u> is anything that alters the natural flow of surface or in-ground water. Structures include, but are not limited to, residences, commercial facilities, foundations, slabs, garages, patios, barns, above- and below-ground swimming pools, retaining walls, roads, driveways, and parking areas. Ohio regulations refer to “structure” by the term “hardscape.”
Surface Diversion	A <u>surface diversion</u> is a natural or manmade barrier that changes the course of surface flow of water around an onsite system’s soil absorption field.
System Bed	The <u>system bed</u> is the minimum System Sand area required in Advanced Enviro-Septic™ systems. The system bed extends a minimum of 12 in. below, 6 in. above and 12 in. horizontally from the outside edges of the pipes in the system.
System Sand	<u>System Sand</u> is the sand used in an Advanced Enviro-Septic™ system. It is critical to the proper functioning of the Advanced Enviro-Septic™ system that the proper amount and type of System Sand be installed. Detailed information about System Sand requirements can be found in Section L, System Sand & Fill Material Specifications, p. 48.
System Sand Extension Area	The <u>System Sand extension area</u> is any part of the System Sand bed which is more than 1ft. from the outermost perimeter of Advanced Enviro-Septic™ pipes. The System Sand extension area is a minimum of 6in. deep. In a system that slopes 5% and less, the System Sand Extension area is added to the width of the system bed, extending equally on both sides of the Advanced Enviro-Septic™ pipes. In a system with a slope greater than 5%, the entire System Sand extension area is added to the system width on the down slope side. See drawings on pp. 24-25.
Topsoil (a.k.a. Loam)	<u>Topsoil</u> , also known as <u>Loam</u> , is soil material capable of sustaining plant growth. Detailed information about soil cover requirements is found in Section L, System Sand and Fill Material Specifications, p. 48.
